

DS-2CD2327G2-L(U)

2 MP ColorVu Fixed Turret Network Camera

ColorVu



Hikvision ColorVu technology provides 24/7 vivid colorful images with F1.0 advanced lenses, high performance sensors and friendly lighting. F1.0 super-aperture collects more light to produce brighter images. Advanced sensor technology can vastly improve the utilization of available light. In zero-light scenarios, built-in, warm supplemental lighting works to guarantee colorful images.

- High quality imaging with 2 MP resolution
- Efficient H.265+ compression technology
- Clear imaging against strong back light due to 120 dB WDR technology
- Built-in microphone for real-time audio security(-U)
- Focusing on human and vehicle classification based on deep learning
- 24/7 colorful imaging



▪ Specification

| Camera | |
|-----------------------------|--|
| Image Sensor | 1/2.8" Progressive Scan CMOS |
| Min. Illumination | 0.0005 Lux @ (F1.0, AGC ON), 0 Lux with Light |
| Shutter Speed | 1/3 s to 1/100,000 s |
| Slow Shutter | Yes |
| P/N | P/N |
| Wide Dynamic Range | 120 dB |
| Angle Adjustment | Pan: 0° to 360°, tilt: 0° to 75°, rotate: 0° to 360° |
| Lens | |
| Depth of Focus | 2.8 mm, 1.7 m to ∞ 4 mm, 2.3 m to ∞ 6 mm, 5.3 m to ∞ |
| Lens Type & FOV | 2.8 mm, horizontal FOV 107°, vertical FOV 56°, diagonal FOV 127° 4 mm, horizontal FOV 84°, vertical FOV 45°, diagonal FOV 99° 6 mm, horizontal FOV 55°, vertical FOV 30°, diagonal FOV 63° |
| Aperture | F1.0 |
| Lens Mount | M12 |
| DORI | |
| DORI | 2.8 mm, D: 46 m, O: 18 m, R: 9 m, I: 4 m 4 mm, D: 56 m, O: 22 m, R: 11 m, I: 5 m 6 mm, D: 83 m, O: 33 m, R: 16 m, I: 8 m |
| Illuminator | |
| White Light Range | 30 m |
| Smart Supplement Light | Yes |
| Video | |
| Max. Resolution | 1920 × 1080 |
| Main Stream | 50Hz: 25 fps (1920 × 1080, 1280 × 720) 60Hz: 30 fps (1920 × 1080, 1280 × 720) |
| Sub Stream | 50Hz: 25 fps (640 × 480, 640 × 360, 320 × 240) 60Hz: 30 fps (640 × 480, 640 × 360, 320 × 240) |
| Third Stream | 50Hz: 25 fps (1280 × 720, 640 × 480, 640 × 360, 320 × 240) 60Hz: 30 fps (1280 × 720, 640 × 480, 640 × 360, 320 × 240) |
| Video Compression | Main stream: H.265/H.264/H.264+/H.265+ Sub-stream: H.265/H.264/MJPEG Third stream: H.265/H.264 |
| Video Bit Rate | 32 Kbps to 8 Mbps |
| H.264 Type | Baseline Profile/Main Profile/High Profile |
| H.265 Type | Main Profile |
| H.264+ | Main stream supports |
| H.265+ | Main stream supports |
| Bit Rate Control | CBR/VBR |
| Scalable Video Coding (SVC) | Yes |
| Region of Interest (ROI) | 1 fixed region for each stream |

| Audio | |
|--|---|
| Environment Noise Filtering | -U: Yes |
| Audio Sampling Rate | -U: 8 kHz/16 kHz/32 kHz/44.1 kHz/48 kHz |
| Audio Compression | -U: G.711ulaw/G.711alaw/G.722.1/G.726/MP2L2/PCM/MP3 |
| Audio Bit Rate | -U: 64Kbps(G.711ulaw/G.711alaw)/16Kbps(G.722.1)/16Kbps(G.726)/32-192Kbps(MP2L2)/ 8-320Kbps(MP3) |
| Network | |
| Simultaneous Live View | Up to 6 channels |
| API | ONVIF (PROFILE S, PROFILE G, PROFILE T), ISAPI, SDK |
| Protocols | TCP/IP, ICMP, HTTP, HTTPS, FTP, DHCP, DNS, DDNS, RTP, RTSP, NTP, UPnP, SMTP, IGMP, 802.1X, QoS, IPv4, IPv6, UDP, Bonjour, SSL/TLS, PPPoE, SNMP |
| User/Host | Up to 32 users. 3 user levels: administrator, operator and user |
| Security | Password protection, complicated password, HTTPS encryption, IP address filter, Security Audit Log, basic and digest authentication for HTTP/HTTPS, TLS 1.2, WSSE and digest authentication for ONVIF |
| Network Storage | MicroSD/SDHC/SDXC card (256 GB) local storage, and NAS(NFS, SMB/CIFS), auto network replenishment (ANR) |
| Client | iVMS-4200, Hik-Connect, Hik-Central |
| Web Browser | Plug-in required live view: IE 8+, Chrome 41.0-44, Firefox 30.0-51, Safari 8.0-11 Plug-in free live view: Chrome 57.0+, Firefox 52.0+ |
| Image | |
| Day/Night Switch | Day, Night, Auto, Schedule |
| Image Enhancement | BLC, HLC, 3D DNR |
| Image Parameters Switch | Yes |
| Image Settings | Rotate mode, saturation, brightness, contrast, sharpness, gain, white balance adjustable by client software or web browser |
| Interface | |
| Built-in Microphone | -U: Yes |
| On-board Storage | Built-in micro SD/SDHC/SDXC slot, up to 256 GB |
| Hardware Reset | Yes |
| Communication Interface | 1 RJ45 10M/100M self-adaptive Ethernet port |
| Smart Feature-Set | |
| Basic Event | Motion detection, video tampering alarm, exception (network disconnected, IP address conflict, illegal login, HDD full, HDD error), scene change detection |
| Intelligent (Deep Learning Algorithm) | |
| Face Capture | Yes |
| Perimeter Protection | Line crossing detection, intrusion detection, region entrance detection, region exiting detection |
| General | |
| Linkage Method | Upload to NAS/memory card, notify surveillance center, trigger record, trigger capture |
| Web Client Language | 33 languages English, Russian, Estonian, Bulgarian, Hungarian, Greek, German, Italian, Czech, Slovak, French, Polish, Dutch, Portuguese, Spanish, Romanian, Danish, Swedish, Norwegian, Finnish, Croatian, Slovenian, Serbian, Turkish, Korean, Traditional Chinese, Thai, Vietnamese, Japanese, Latvian, Lithuanian, Portuguese (Brazil), Ukrainian |

| | |
|----------------------------------|---|
| General Function | Anti-flicker, heartbeat, mirror, privacy masks, flash log, password reset via e-mail, pixel counter |
| Software Reset | Yes |
| Storage Conditions | -30 °C to 60 °C (-22 °F to 140 °F). Humidity 95% or less (non-condensing) |
| Startup and Operating Conditions | -30 °C to 60 °C (-22 °F to 140 °F). Humidity 95% or less (non-condensing) |
| Power Supply | 12 VDC ± 25%, PoE: 802.3af, class 3 |
| Power Consumption and Current | 12 VDC, 0.5 A, max. 6 W PoE: (802.3af, 36 V to 57 V), 0.2 A to 0.12 A, max. 7 W |
| Power Interface | Ø5.5 mm coaxial power plug |
| Material | Aluminum alloy body, except for trim ring |
| Screw Material | SUS304 |
| Camera Dimension | Ø138.3 × 125.2 mm (Ø5.4" × 4.9") |
| Package Dimension | 170 × 170 × 150 mm (7" × 7" × 5.9") |
| Camera Weight | Approx. 700 g (1.5 lb.) |
| With Package Weight | Approx. 995 g (2.2 lb.) |
| Approval | |
| Class | Class B |
| EMC | FCC SDoC (47 CFR Part 15, Subpart B); CE-EMC (EN 55032: 2015, EN 61000-3-2: 2014, EN 61000-3-3: 2013, EN 50130-4: 2011 +A1: 2014); RCM (AS/NZS CISPR 32: 2015); IC VoC (ICES-003: Issue 6, 2016); KC (KN 32: 2015, KN 35: 2015) |
| Safety | UL (UL 60950-1); CB (IEC 60950-1:2005 + Am 1:2009 + Am 2:2013, IEC 62368-1:2014); CE-LVD (EN 60950-1:2005 + Am 1:2009 + Am 2:2013, IEC 62368-1:2014); BIS (IS 13252(Part 1):2010+A1:2013+A2:2015); LOA (IEC/EN 60950-1) |
| Environment | CE-RoHS (2011/65/EU); WEEE (2012/19/EU); Reach (Regulation (EC) No 1907/2006) |
| Protection | Ingress protection: IP67 (IEC 60529-2013) |

▪ Available Model

DS-2CD2327G2-LU (2.8 mm, 4 mm, 6 mm)

DS-2CD2327G2-L (2.8 mm, 4 mm, 6 mm)



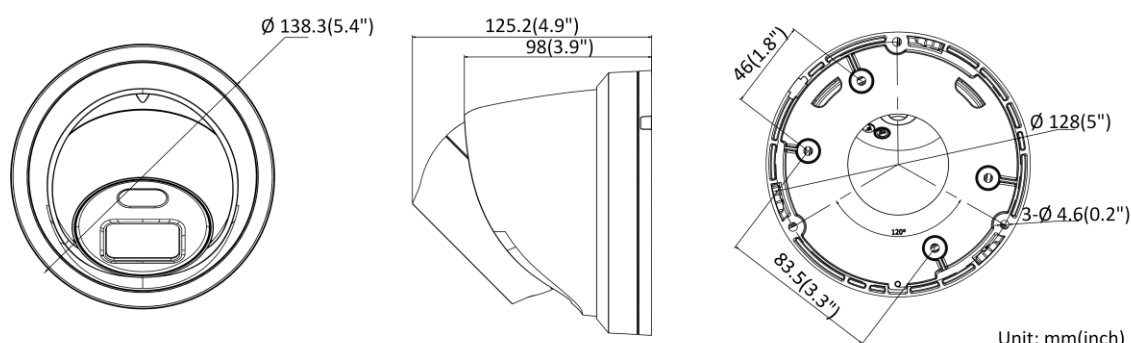









▪ Dimension

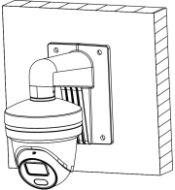

Unit: mm(inch)

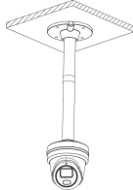
▪ **Accessory**

▪ **Optional**

| DS-1276ZJ-SUS Corner Mount | DS-1273ZJ-140 Wall Mount | DS-1273ZJ-140B Wall Mount | DS-1271ZJ-140 Pendant Mount | DS-1275ZJ-SUS Vertical Pole Mount |
|---|---|---|---|---|
|  |  |  |  |  |
|  |  |  |  |  |
| <p>DS-1280ZJ-DM21 Junction Box</p> | | | | |
|  | | | | |
|  | | | | |



Distributed by

**HIKVISION®****Headquarters**

No.555 Qianmo Road, Binjiang District,
Hangzhou 310051, China
T +86-571-8807-5998
overseasbusiness@hikvision.com

Hikvision USA

T +1-909-895-0400
sales.usa@hikvision.com

Hikvision Australia

T +61-2-8599-4233
salesau@hikvision.com

Hikvision India

T +91-22-28469900
sales@pramahikvision.com

Hikvision Canada

T +1-866-200-6690
sales.canada@hikvision.com

Hikvision Thailand

T +662-275-9949
sales.thailand@hikvision.com

Hikvision Europe

T +31-23-5542770
sales.eu@hikvision.com

Hikvision Italy

T +39-0438-6902
info.it@hikvision.com

Hikvision Brazil

T +55 11 3318-0050
Latam.support@hikvision.com

Hikvision Turkey

T +90 (216)521 7070- 7074
sales.tr@hikvision.com

Hikvision Malaysia

T +601-7652-2413
sales.my@hikvision.com

Hikvision UK & Ireland

T +01628-902140
sales.uk@hikvision.com

Hikvision South Africa

Tel: +27 (10) 0351172
sale.africa@hikvision.com

Hikvision France

T +33(0)1-85-330-450
info.fr@hikvision.com

Hikvision Kazakhstan

T +7-727-9730667
nikia.panfilov@hikvision.ru

Hikvision Vietnam

T +84-974270888
sales.vt@hikvision.com

Hikvision UAE

T +971-4-4432090
salesme@hikvision.com

Hikvision Singapore

T +65-6684-4718
sg@hikvision.com

Hikvision Spain

T +34-91-737-16-55
info.es@hikvision.com

Hikvision Tashkent

T +99-87-1238-9438
uzb@hikvision.ru

Hikvision Hong Kong

T +852-2151-1761
info.hk@hikvision.com

Hikvision Russia

T +7-495-669-67-99
saleru@hikvision.com

Hikvision Korea

T +82-(0)31-731-8817
sales.korea@hikvision.com

Hikvision Poland

T +48-22-460-01-50
info.pl@hikvision.com

Hikvision Indonesia

T +62-21-2933759
Sales.Indonesia@hikvision.com

Hikvision Colombia

sales.colombia@hikvision.com