

ANALOGUE

FIRE CONTROL PANEL

FC500



INSTALLATION MANUAL



BENTEL[®]
SECURITY



This Fire Control panel can be programmed only using the Software **FireClass500** Console release 2.0 or higher.

Control panel FW ver. 2.0 or higher.

BENTEL SECURITYsrl shall not assume the responsibility for damage arising from improper application or use.

This Fire Control panel has been designed and manufactured to the highest standards of quality and performance.

Installation of this Control panel must be carried out strictly in accordance with the instructions described in this manual, and in compliance with the local laws and bylaws in force

The **FC510** and **FC520** Fire Control panels comply with the essential requirements of standards **EN54-2; EN54-4**.

| |
|---|
|  |
| 0051 BENTEL SECURITY s.r.l. Via Gabbiano, 22 - Zona Ind. S. Scolastica 64013 Corropoli (TE) - ITALY 09 0051-CPD-0198 (FC500PSTN in FC510/FC520) |
| EN 54-21 Alarm transmission and fault warning routing equipment for fire alarm systems installed in buildings. |

| |
|---|
|  |
| 0051 BENTEL SECURITY s.r.l. Via Gabbiano, 22 - Zona Ind. S. Scolastica 64013 Corropoli (TE) - ITALY 09 0051 - CPD - 0190 (FC510) 0051 - CPD - 0191 (FC520) |
| EN 54-2:1997+A1:2006 Control and indicating equipment for fire detection and fire alarm systems for buildings. EXPECTED OPTIONS Fault signals from points Dependencies on more than one alarm signal: type (A and C) Delays to outputs Disablement of addressable point Test condition Output to fire alarm devices |

Recycling information

BENTEL SECURITY recommends that customers dispose of their used equipments (panels, detectors, sirens, and other devices) in an environmentally sound manner. Potential methods include reuse of parts or whole products and recycling of products, components, and/or materials.

For specific information see: :

<http://www.bentelsecurity.com/index.php?o=environmental>

Waste Electrical and Electronic Equipment (WEEE) Directive



In the European Union, this label indicates that this product should NOT be disposed of with household waste. It should be deposited at an appropriate facility to enable recovery and recycling.

For specific information see:

<http://www.bentelsecurity.com/index.php?o=environmental>

NOTE- The series FC500 Fire control panel can support several addressable devices (Detectors, Modules, Manual call Points, etc). The present manual includes the instructions for their programming, but for further informations on those devices and their accessories, please visits: www.bentelsecurity.com , logging in the **Reserved Area**, under **Installation Manuals**.

BENTEL SECURITY srl reserves the right to change the technical specifications of these products without prior notice.

| |
|---|
|  |
| 0051 BENTEL SECURITY s.r.l. Via Gabbiano, 22 - Zona Ind. S. Scolastica 64013 Corropoli (TE) - ITALY 12 0051-CPD-0366 (FC500IP in FC510/FC520) |
| EN 54-21 Alarm transmission and fault warning routing equipment for fire alarm systems installed in buildings. |

TABLE of CONTENTS

| | | | |
|--|-----------|---|-----------|
| INTRODUCTION | 5 | PC PROGRAMMING | 29 |
| FC500 Fire Contro Panel | 5 | Introduction | 29 |
| <i>Accessory Items</i> | 5 | Installation | 29 |
| Description | 5 | Select language | 29 |
| <i>Input</i> | 5 | Software window Look | 29 |
| <i>Outputs</i> | 5 | Control panel connections | 29 |
| <i>Operating Features</i> | 6 | Main window | 29 |
| <i>Interface</i> | 8 | <i>Icons description</i> | 30 |
| <i>Access to Signalling and Commands</i> | 8 | <i>File</i> | 30 |
| <i>Power Supply</i> | 8 | <i>Communication</i> | 31 |
| | | <i>Options</i> | 31 |
| | | <i>Database</i> | 31 |
| | | <i>Mode setup</i> | 31 |
| | | <i>Help</i> | 31 |
| PARTS IDENTIFICATION | 9 | Devices programming | 31 |
| The status LED | 9 | <i>Description of the icons in the tool bar.</i> | 31 |
| Description of Parts | 14 | <i>Parameters detectors programming</i> | 32 |
| LEDs and KEYS Labels | 17 | <i>Input modules programming</i> | 33 |
| Description of the Control keys | 18 | <i>Output modules programming</i> | 33 |
| | | <i>Multiple Input-Output Module - Programming</i> | |
| | | <i>Parameters (FC410MIO)</i> | 33 |
| | | <i>Manual Call Point programming parameters</i> | 34 |
| INSTALLATION | 19 | Zones programming | 34 |
| Installing accessory boards | 19 | Outputs Programming | 34 |
| Installing FC500REP Repeaters | 19 | <i>NAC1, NAC2 and NAC3 Outputs</i> | 34 |
| Installing the FC500PS e FC500IP board | 19 | <i>OS1....OS8 Outputs</i> | 35 |
| Installing the FC500 Slave control panel | 19 | <i>O9....O16 Outputs</i> | 35 |
| Installing the Control panel | 19 | General Options programming | 35 |
| Description of the Terminals | 20 | PSTN interface | 36 |
| <i>Main Board terminals</i> | 20 | IP interface | 37 |
| The System Wiring | 21 | CLOCK | 37 |
| Connecting Addressable Analogue Devices | 21 | LOG | 37 |
| <i>Connecting Conventional Devices</i> | 22 | Battery Calculation | 37 |
| Connecting Repeater and Slave Control panel | 23 | Loop Wiring calculation | 37 |
| Connecting Output Devices | 23 | User mode | 40 |
| <i>Bell Outputs</i> | 23 | | |
| Connecting a Power Supply | 24 | | |
| <i>Thermal Probe</i> | 25 | | |
| Installing the 38Ah battery metal Box | 27 | | |
| Maintenance | 27 | | |

| | |
|---|-----------|
| PROGRAMMING FROM THE PANEL | 41 |
| Using the system | 41 |
| <i>L1= First Level: this level allows the Reading Parameters ONLY:</i> | 41 |
| <i>L2= Second Level or USER Level: access to this level requires entry of the USER PIN (Access Level 2).</i> | 41 |
| <i>L3= Third Level or INSTALLER Level: access to this level requires entry of the INSTALLER PIN (Access Level 3).</i> | 41 |
| <i>Operating the system</i> | 41 |
| Main Page - Accessing the system | 42 |
| Insert password | 43 |
| Programming Page | 44 |
| 1 KEY- Auto Enrolling (Autolearning) | 44 |
| <i>Warning Enrolling (Autolearning)</i> | 44 |
| 0 KEY - insert-Modify password | 45 |
| 9 KEY- Restore Default | 46 |
| KEY 2 -Device | 46 |
| KEY 3- SW zone | 47 |
| Detector alarm verification (Smoke delay) | 47 |
| 4 KEY- OUTPUT | 48 |
| <i>Choose Output</i> | 48 |
| NAC active on disablements | 48 |
| 5 Key- Network | 49 |
| FC500-MFI programming Procedure | 49 |
| KEY 6-TELECOM | 50 |
| KEY 7-OPTIONS | 50 |
| KEY 8-SYSTEM | 51 |
| FC500REP Repeater Address | |
| from the Repeater panel ONLY | 51 |
| NETWORK Configuration | 51 |
| <hr/> | |
| QUICK START-UP PROCEDURE | 52 |
| PROCEDURE | 52 |
| <i>Detectors</i> | 52 |
| <i>Modules</i> | 52 |
| <i>Zones</i> | 53 |
| <i>Panel outputs</i> | 53 |
| <i>Conventional zone</i> | 53 |
| <i>Panel general option</i> | 53 |

| | |
|---|-----------|
| ACCESSORY | 54 |
| FC500IP - IP Module | 54 |
| FC500PSTN - Telecom Module | 54 |
| 5B - Universal Base | 54 |
| FC400H or FC460H - Addressable Heat Detector | 54 |
| FC400P or FC460P - Addressable Optical Smoke | 54 |
| FC400PH or FC460PH - Addressable Optical Smoke & Heat Detector | 54 |
| FC410LI - Line Isolator Module | 55 |
| FC410MIM - Mini Input Module | 55 |
| FC410MIO - Small Addressable Multi I/O Module | 55 |
| FC410SIO - Single Input/Output Module | 55 |
| FC420CP - Addressable Break Glass Callpoint (indoor) | 55 |
| FC421CP - Addressable Break Glass Callpoint (outdoor) | 55 |
| FC430SAB/SAM - Sounder Base Address Modules | 55 |
| FC430SB - Loop Low Power Sounder Base | 55 |
| FC450IB - Isolator Base | 56 |
| FC490ST - Loop Service Tool | 56 |
| FC410BDM - Beam Detector Module | 56 |
| FC410CIM - Contact Input Module | 56 |
| FC410DIM - Detector Input Module | 56 |
| FC410RIM - Relay Interface Module | 56 |
| FC400CH - Addressable Carbon Monoxide + Heat Detector | 56 |
| 801RIL - Remote LED Indicator | 56 |
| 801HL - Remote LED Indicator | 56 |
| HVR800-High Voltage Relay | 56 |
| MP69-Duct Probe Unit | 57 |
| FIRERAY 50-Optical Beam Smoke Detector | 57 |
| FC410LPSY and FC410LPAV loop powered sounders and sounder-beacons | 57 |
| FC430LPSB and FC430LPASB Loop Powered Addressable Sounder/Beacon Base | 57 |
| FC410SNM Sounder Notification Module | 57 |
| FC410TSM – door control module | 57 |
| FC410DDM – Universal fire and gas detector module | 57 |
| FC410QIO Quad input output module | 58 |
| FC410QRM Quad relay module | 58 |
| <hr/> | |
| QUICK GUIDE | 59 |
| Technical features | 59 |
| Description of the terminals | 59 |

FC500 Fire Control Panel

In this manual we will use the term FC500 control panel to indicate the common features of Fire control panel. Otherwise we will use the specific terms.

FC500 Fire control panel is available in the following models:

- **FC510** - Analogue addressable Fire Control Panel with one not expandable Loop and with Switching Power supply 5,5 A;
- **FC520** - Analogue addressable Fire Control Panel with two not expandable Loops and with Switching Power supply 5,5 A;

 *The components of these Control panels operate as intended when the external ambient conditions comply with the requirements of class EN 60721-3-3:1995.*

The Loops of FC500 control panel provide the following features:

- max 250 analogue devices.
- The conventional line of the FC500 control Panel can support up to 30 devices.
In any case, FC500 Fire control panel cannot support more than 2000 devices (500 devices for every couple of Loop) (up to 2000 m (Loop) with shielded cable 2x2.5).

The FC500 control panel must be powered by BENTEL BAQ140T24 (27,6 V - 5,5 A) switching power supply.

Moreover all FC500 models provide housing for an LCD module with 40 characters for line and 4 lines backlit, which provides written information regarding the system status and for programming the control panel.

■ Accessory Items

FC500REP This Repeater panel is intended for connection (via 4 wires) to **FC500** Control panels. It provides all the visual and audible warnings generated by the Control panel and allows end-users to manage the system from a remote location (up to 1000 m, with double twist shielded cable).

The **FC500** "Master" Control panels can support up to (8) eight **FC500REP** Repeater panels.

FC500 Slave The **FC500** "Master" Control panels can support up to (7) seven FC500 Slave Control panels. These Control Panels can be used to expand the FC500 system, in modular way.

Software FireClass500 Console This user-friendly software application (Windows) offers a quick and easy way to program the Control panel and provides event log functions.

Description

■ Input

250 devices max every Loop

30 devices max on the conventional line

■ Outputs

This section describes how the Control panel outputs operate.

Supervised outputs The Control panel will be able to detect and signal short-circuits and power supply interruptions on this type of output.

Bypassable(Disabled) outputs The user will be able to disable (by means of the respective key) this type of output.

Silenceable outputs The user will be able to stop (via the **Silence** key) this type of output.

The outputs can be silenced for an indefinite period (during Day Mode), or for the programmed Silence Time (during Night Mode).

■ Operating Features

Warning The FC500 control panel can be programmed to provide WARNINGS or PREALARMS status before ALARM status.

This status will be signalled by the WARNING display. The panel will generate a warning when an input point (detector) exceeds its warning threshold and there is risk of an alarm.

-WARNING STATUS will be signalled by:

- a screen on LCD display
- the WARNING output points if the **Pre-alarm** option is enabled;

Pre-alarm If a zone generates an alarm during Day Mode, the Control panel will start the **Pre-alarm Time**. This status will be signalled by:

- a **slow intermittent** beep;
- glowing on the **Pre-al.** LED;
- a screen on LCD display
- Activation of respective outputs, if the **Pre-alarm** option is enabled;

 *This Control panel will generate an Instant Alarm if alarm conditions are detected during **Night Mode** or if an alarm is triggered from a Callpoint.*

During Pre-alarm status, you will be able to:

- activate an Evacuation Alarm by pressing and holding the **Evacuate** Key (**Access Level 1** — refer to “Access to signalling and commands”),
- stop the Silenceable outputs and interrupt the Pre-alarm Time by pressing the **Silence** key (**Access Level 2**).

During **Silence** status (**Silence** LED glowing), it is possible to use the **Silence** key to release the **Silenceable** outputs, or use the **Reset** key to restore standby status.

 *If the Control panel is operating in Night Mode, the Control panel will exit **Silence** status automatically when the programmed **Night mode Silence time** expires.*

Alarm The Control panel will generate an alarm when the **Pre-Alarm Time** expires. Alarm status will be signalled by:

- a **fast intermittent** beep;
- glowing on the **Alarm** LEDs;
- a screen on LCD display;
- activation of the **NAC FIRE** output;
- activation of the **FIRE** outputs;
- activation of other programmed outputs

During Alarm status, **PIN Code users** (**Access Level 2** — refer to “Access to signalling and commands”) will be able to:

- stop the Silenceable outputs by pressing the **Silence** key.

During **Silence** status (**Silence** LED glowing), it is possible to use the **Silence** key to release the **Silenceable** outputs, and the **Reset** key to restore standby status.

 *If the Control panel is in Night Mode (**Day Mode** LED OFF), the Control panel will exit **Silence** status when the programmed **Night mode Silence time** expires*

Day/Night Mode The control panel can operate in DAY or NIGHT Mode. See "PC PROGRAMMING" chapter.

If the system is silenced during DAY Mode, SILENCE status will be held until the system is unsilenced (i.e. unless new alarms). If the system is silenced during NIGHT Mode, SILENCE status will be held until the Night Mode Silence time expires.

On power up (at default) the system will set to DAY Mode. During this operating mode, silenced alarms/fauls will not be unsilenced automatically until the Night Mode Silence time expires.

Fault This Control panel can detect and signal the Faults shown in the Table n.1:

Fault conditions will be signalled by:

- a **slow intermittent** beep (at 1 second intervals);
- glowing on the **Fault** LED and on relative Fault LED;
- a screen on LCD display;
- activation of the **Fault** output;
- activation of other programmed outputs;
- slow blinking on the Fault LED.

The **Fault** output and other outputs (if duly programmed by your Installer) will restore to standby automatically when fault conditions clear.

Under certain circumstances, fault conditions may clear spontaneously, if this occurs, the event will be stored in the memory until the Control panel Resets.

Stored Fault events will be signalled by:

- slow blinking on the Fault LED.

| | |
|----------------------|--|
| Switching 1 | <i>Switching 1 Fault</i> |
| Switching 2 | <i>Switching 2 Fault</i> |
| Mains fault | <i>The Control panel is NOT powered from the Mains</i> |
| Battery | <i>The Control panel batteries charger not working properly</i> |
| Low battery | <i>The Control panel batteries are empty</i> |
| Earth | <i>Leakage to Earth</i> |
| 24A Output | <i>24A Output is shorted</i> |
| 24R Output | <i>24R Output is shorted</i> |
| Conv. zone open | <i>Conventional zone (LC terminal) open</i> |
| Conv. zone short | <i>Conventional zone (LC terminal) is shorted</i> |
| Flash writing | <i>Flash writing error</i> |
| Flash erasing | <i>LOG erasing error</i> |
| Main controller | <i>Main controller fault</i> |
| Firmware main contr. | <i>Checksum fault</i> |
| Prog.data main cont | <i>Data programming Checksum fault</i> |
| Firmware Display | <i>Display Checksum fault</i> |
| Loop Communication | <i>Communication Loop fault controller</i> |
| Loop return open | <i>Loop negative signal open</i> |
| Loop signal open | <i>Loop positive signal open</i> |
| Loop local short | <i>Local short on Loop controller</i> |
| Loop right short | <i>Right side Loop short</i> |
| Loop left short | <i>Left side Loop short</i> |
| Non answer | <i>Loop device doesn't answer</i> |
| Dirty level | <i>(Smoke detector ONLY) the dirty threshold has been exceeded</i> |
| Short circuit | <i>Short circuit on Input module</i> |
| Open circuit | <i>Open circuit on Input module</i> |
| Power supply | <i>Main fault</i> |
| Wrong value | <i>A Loop device has a wrong value</i> |
| Stuck output | <i>An Output module relais is not switched</i> |
| Same address | <i>Loop several devices have the same address</i> |
| Display communic. | <i>Communication fault on Display controller</i> |
| LOG Full | <i>LOG fault</i> |
| LOG not valid | <i>LOG contents not valid</i> |
| OS1 Open | <i>OS1 terminal (Supervised output) open</i> |
| OS2 Open | " |
| OS3 Open | " |
| OS4 open | " |
| OS5 open | " |
| OS6 open | " |
| OS7 open | " |
| OS8 open | " |
| OS1 short | <i>OS1 terminal is shorted</i> |
| OS2 short | " |

| | |
|-----------------------|--|
| OS3 short | " |
| OS4 short | " |
| OS5 short | " |
| OS6 short | " |
| OS7 short | " |
| OS8 short | " |
| TRANSISTOR OS1 | <i>OS1 Transistor fault</i> |
| TRANSISTOR OS2 | " |
| TRANSISTOR OS3 | " |
| TRANSISTOR OS4 | " |
| TRANSISTOR OS5 | " |
| TRANSISTOR OS6 | " |
| TRANSISTOR OS7 | " |
| TRANSISTOR OS8 | " |
| NAC FIRE short | <i>NAC Fire terminal is shorted</i> |
| NAC 1 short | " |
| NAC 2 short | " |
| NAC 3 short | " |
| NAC FIRE open | <i>NAC FIRE terminal is open</i> |
| NAC 1open | <i>NAC1 terminal is open</i> |
| NAC 2open | " |
| NAC 3open | " |
| Transistor NAC FIRE | <i>NAC FIRE transistor fault</i> |
| Transistor NAC 1 | <i>NAC 1 transistor fault</i> |
| Transistor NAC 2 | " |
| Transistor NAC 3 | " |
| Device not programmed | <i>Device on the loop without address</i> |
| Incorrect type | <i>Device on the loop different from the one programmed in the control unit</i> |
| Noisy loop | <i>The devices on the loop are not communicating correctly with the control unit (check the quality of the wiring)</i> |
| Control unit transm. | <i>A 485 control unit is not responding</i> |
| Repeater transm.,. | <i>A 485 repeater is not responding</i> |
| Control panel Fault | <i>A 485 control panel has a fault</i> |
| Prog. data Controller | <i>An error has been detected in the Controller programming Data</i> |

Table 1 *Faults Table*

Silence This Control panel provides a **Silence** key which can be used to restore the Silenceable outputs to standby status.

Silence status will be signalled by:

- glowing on the **Silence** LED.

Silence status will be held until the **Silence** key is pressed again or, if the Control panel is operating in **Night Mode**, until the programmed **Night mode Silence time** expires, or until a new Alarm condition is detected.

☞ *Only when the control panel is at Level 2 or at Level 3 can SILENCE the Silenceable outputs.*

Table 1 *Faults table (Continued..)*

Disabled This Control panel can disable: the devices on the Loop (input and Output devices), the bell outputs, the software zones; the network devices (Repeaters or Slave control panels).

DISABLED zones cannot generate alarms or warnings of any kind, and DISABLED outputs cannot be activated.

Disabled status will be signalled by:

- glowing on the **Disabled** LED;

 *Only when the control panel is at Level 2 or at Level 3 can DISABLE zones and/or outputs.*

Reset Resetting the Control panel will restore the outputs to standby status, clear the memory, and interrupt the power supply to terminals 24R.

 *Only when the control panel is at Level 2 or at Level 3 can Reset the system.*

■ Interface

Visual Signalling The system status will be signalled on the Control panel LEDs as follows:

GREEN indicates normal operating conditions;
AMBER indicates specific operating modes (for example Day or Night mode), and/or Fault conditions;
RED indicates Alarm conditions.

Memory The Control panel will signal Fault events (FAULT LED blinking) until the system Resets, even if the event clears in the meantime.

Audible Signalling The Buzzer will signal the Control panel status as follows:

| Status | Sound | Pause | Description |
|----------|-----------|-------|------------------------|
| Warning | 2 s | 2 s | Slow Intermittent Beep |
| Prealarm | 0,5 s | 0,5 s | Intermittent beep |
| Alarm | 0,2 s | 0,2 s | Fast Intermittent Beep |
| Fault | 1 s | 1 s | Slow Intermittent Beep |
| Reset | no sounds | | |
| Test | no sounds | | |

Table 2 Buzzer signalling

Test LAMP-BUZZ-TEST key will allow ALL users to test the Control panel Buzzer and LEDs.

■ Access to Signalling and Commands

There are 4 access levels, in compliance with the Fire Safety Regulations in force.

Access Level1 (L1) Viewing: **ALL** persons can view the Control panel status (No password requested).

Access Level 2 (L2) Operating the system (PIN Code entered): PIN Code Users can operate the system. (User level)

Access Level 3 (L3) Programming and Opening the Control panel (PIN Code entered): **ONLY Qualified persons with authorization** are allowed to open the Control panel door (requires removal of the screws) for maintenance purposes or replace batteries. (Installer Level).

Access Level 4 Repairing or replacing the PCB: **ONLY the Manufacturer** should be allowed to repair or replace the PCB, (requires removal of the screws).

■ Power Supply

The power supply system of the **FC500** Control panels complies with EN54-4.

All models are powered by the Mains (230 V, 50 Hz):

- the **FC510** model has Switching Power Supply which supplies up to 5.5 A at 27.6 V;
- the **FC520** model has Switching Power Supply which supplies up to 5.5 A at 27.6 V;

All models can house two 12 V batteries which, when connected in series, will supply 24 V to the Control panel and peripherals in the event of black-out, and will also provide any pickup currents which exceed the maximum current supplied by the Switching Power Supply.

The **FC510** and **FC520** model can house two 12V 17 Ah batteries (YUASA NP 17-12 FR model or similar — flame class UL94-V2 or higher).

 *If necessary, (Full configured Loop or for particular requirements of the system) FC510 or FC520 control panel model can be connected to two 12V 38 Ah batteries in an external metal box (see Figure 16).*

This Control panel can detect, signal and store in memory the following power faults: shorted 24V or 24R outputs; Low battery, Battery fault or Battery disconnected (**Low Battery** LED and **No Battery** LED), Ground fault (**Earth** LED) and Mains failure (**Mains** LED).

 *The “No Battery or Low Battery” fault may be signalled with a delay up to 1 minute. The “Mains” (Amber) fault will be signalled when the programmed delay expires.*

PARTS IDENTIFICATION

The status LED

The following section describes how the Control panel LEDs operate. During standby status, ONLY the GREEN Mains LED and the Day mode LED (if the control panel is in Day mode) should be On (glowing) .

 ONLY the two FAULT LEDs **slow blinking** indicate a FAULT event in **memory**.

| LEDs | DESCRIPTION |
|----------------------|--|
| FIRE | Glowing indicates Alarm status. In the event of an Alarm, the Control panel will activate the unbypassed alarm outputs. |
| More Alarms | Glowing indicates more Alarm status. |
| Pre-alarms | Blinking indicates Pre-alarm status. |
| Communicator (Red) | Glowing indicates that transmission was successful. Blinking indicates that transmission is in progress. On display of control panel it is possible to know the connection type: PSTN, GSM, or LAN network. |
| FAULT | Glowing indicates the presence of a Fault: the following LEDs or the screen on the display indicate the type of the Fault. Slow blinking indicates a fault event in memory (Reset turns OFF). |
| Logic Unit | Glowing indicates a blocked Control panel. IMPORTANT: Maintenance required. NOTE – When the Control panel is switched on for the first time, this LED will blink until a Reset has been performed. |
| Lost Device | Glowing indicates that a Loop device has disappeared (missing address). |
| Communicator (Amber) | Glowing indicates the Dialer has been disabled; Slow blinking indicates that the dialer has broken down |
| Nac Fire Output | Glowing indicates that NAC FIRE Output is bypassable (disabled), Slow blinking indicates the presence of a Fault on NAC FIRE Output. |
| Earth | Glowing indicates a Voltage leakage to Earth. IMPORTANT: Check wiring insulation |
| Low Battery | Glowing indicates Batteries empty or faulty. If this condition persists, the batteries will be unable to function as intended in the event of blackout. IMPORTANT: New batteries required. |
| NO Battery | Glowing indicates Batteries empty or disconnected ; check if the connections are correct. |
| MAINS (amber) | Glowing indicates Mains failure (230 V) or Switching Power supply fault. During this condition, the Control panel will be powered by the batteries. |
| Day mode | Glowing indicates that the Control panel is operating in Day Mode OFF indicates that the Control panel is operating in Night Mode |
| Disabled | Glowing indicates the Disabled status of any bypassable entity. |
| Silence | Glowing indicates that Silenceable outputs have been forced to standby by means of SILENCE key; in Day Mode the SILENCE will remain until the SILENCE key will not be pressed again, while in Night Mode after the Silence Time expires automatically the SILENCE will end. |
| Test | Glowing indicates Test conditions on at least one zone. |
| MAINS (Green) | OFF indicates Mains failure (230 V). IMPORTANT: Power must be restored before the batteries empty. |

Table 3 Description of the status LEDs

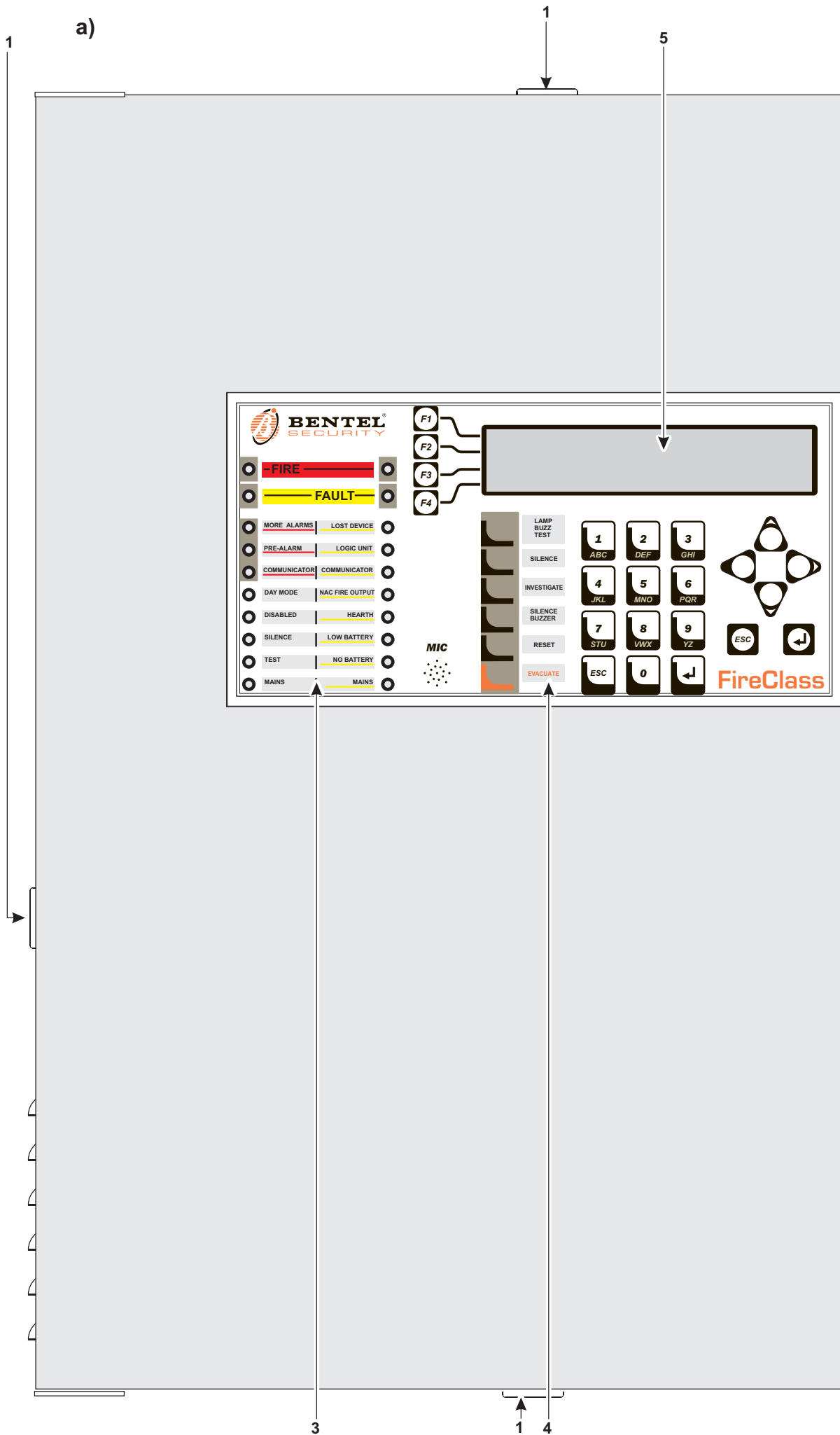
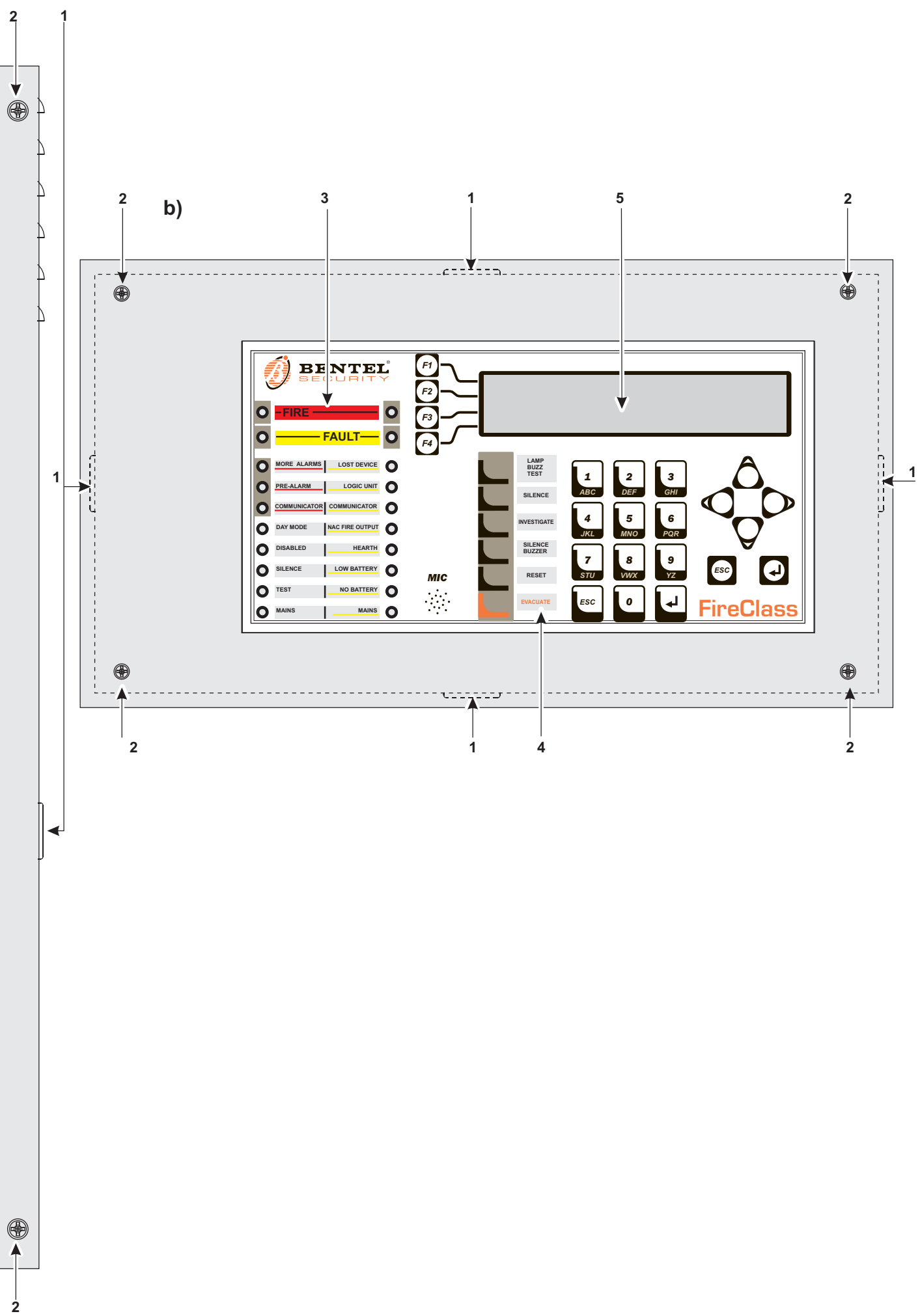

Figure 1 Front view of the FC510, FC520 control panel (a), and of Repeater FC500REP (b)



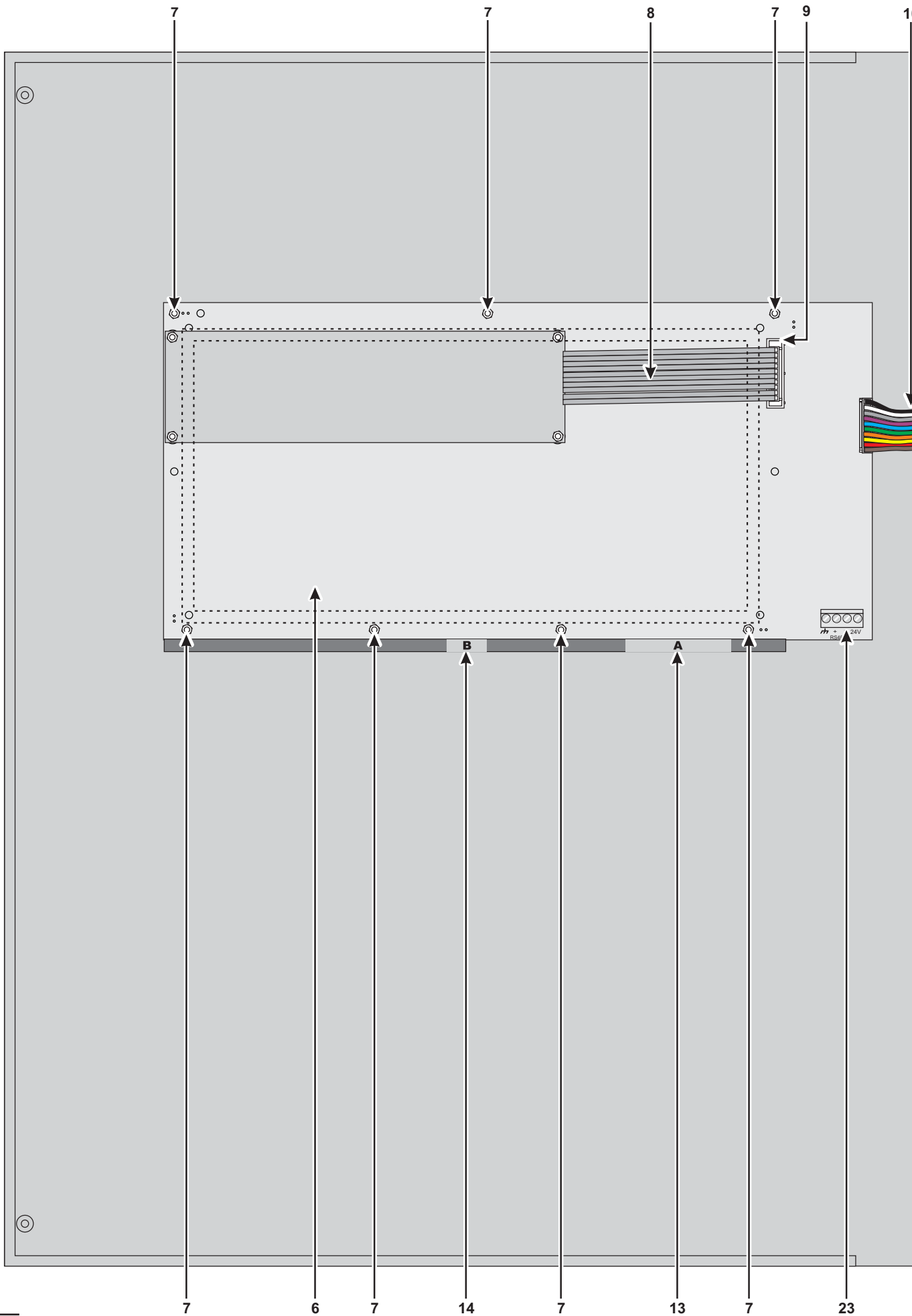
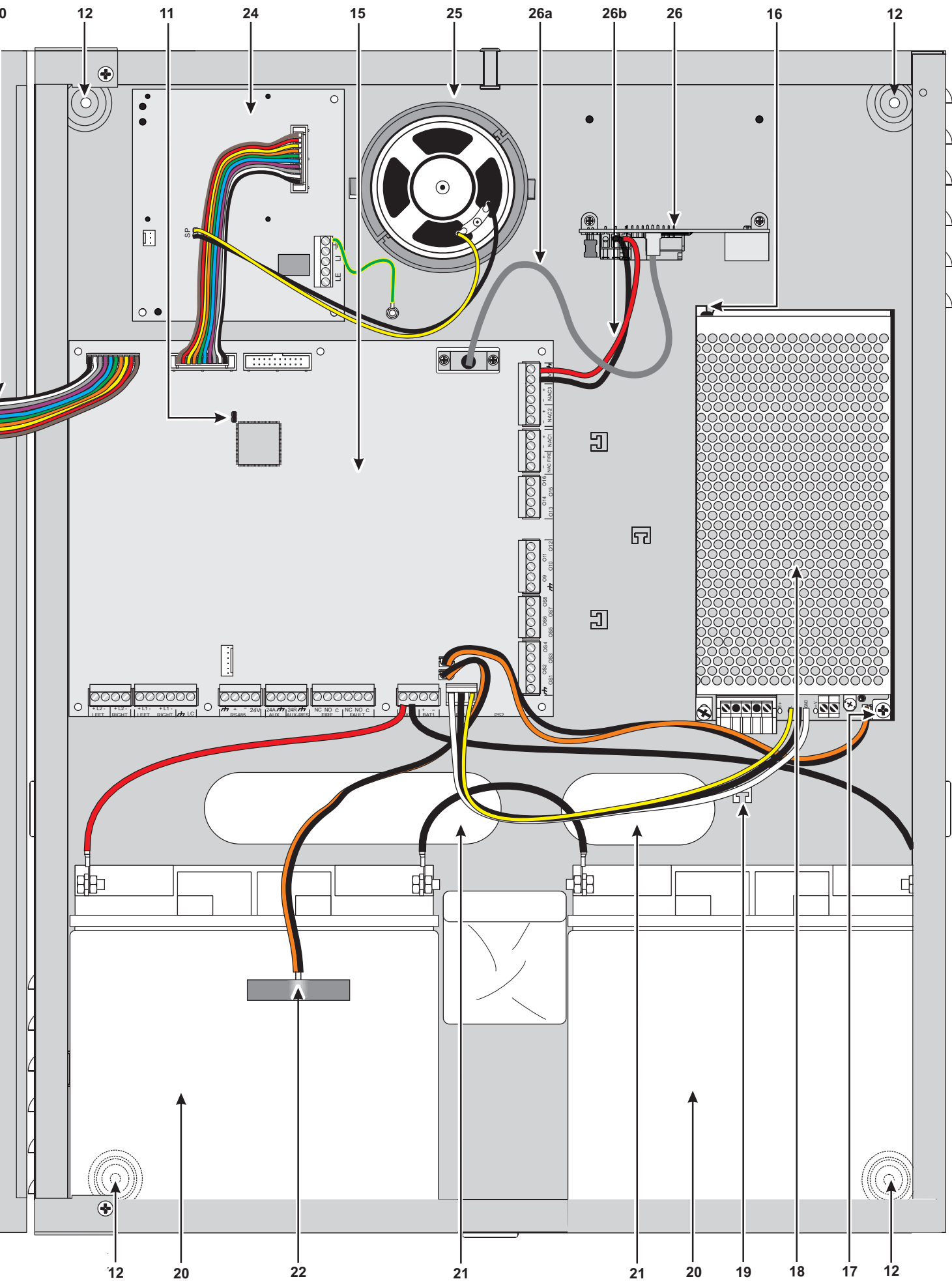

Figure 2 Configuration of the FC510, FC520 control panel.



Description of Parts

This section describes the components of the FC500 serie Control panels, and FC500REP Repeater.

Unless otherwise stated, the numbers in boldface in this Manual refer to the Tables and Diagrams in this section.

The parts identification numbers in the diagrams go clockwise.

| P. | Description |
|----|---|
| 1 | Surface Cable conduit entry |
| 2 | Door screws |
| 3 | LED label slots |
| 4 | KEYs label slots |
| 5 | Display |
| 6 | User interface board |
| 7 | Nuts to secure the User interface board on the cover of Control Panel or Repeater |
| 7a | Earth connection (see figure 3) |

| P. | Description |
|----|---|
| 8 | Flat cable: for the Display module board connection with User interface board |
| 9 | Jack for the connection between display module and User interface board |
| 10 | Flat cable: for the User interface board connection with Main board |
| 11 | Jumper to Default programming (Future use) (Default ) |
| 12 | Anchor screw locations |
| 13 | Signalling LEDs Label |
| 14 | Identification Keys Label |
| 15 | Main Board |
| 16 | Switching power supply support |
| 17 | Switching power supply screw |
| 18 | Switching power supply |
| 19 | Anchor for 230 V power supply wires |
| 20 | Batteries (NOT supplied): FC510, FC520 = 2 da 12 V 17 Ah (Accessory item: 2 da 12V 38 Ah -see figure 16- |
| 21 | Chased cable conduit entry |
| 22 | Thermal probe |
| 23 | Jack for the connection between the User interface to Repeater (RS485 interface accessory item) |

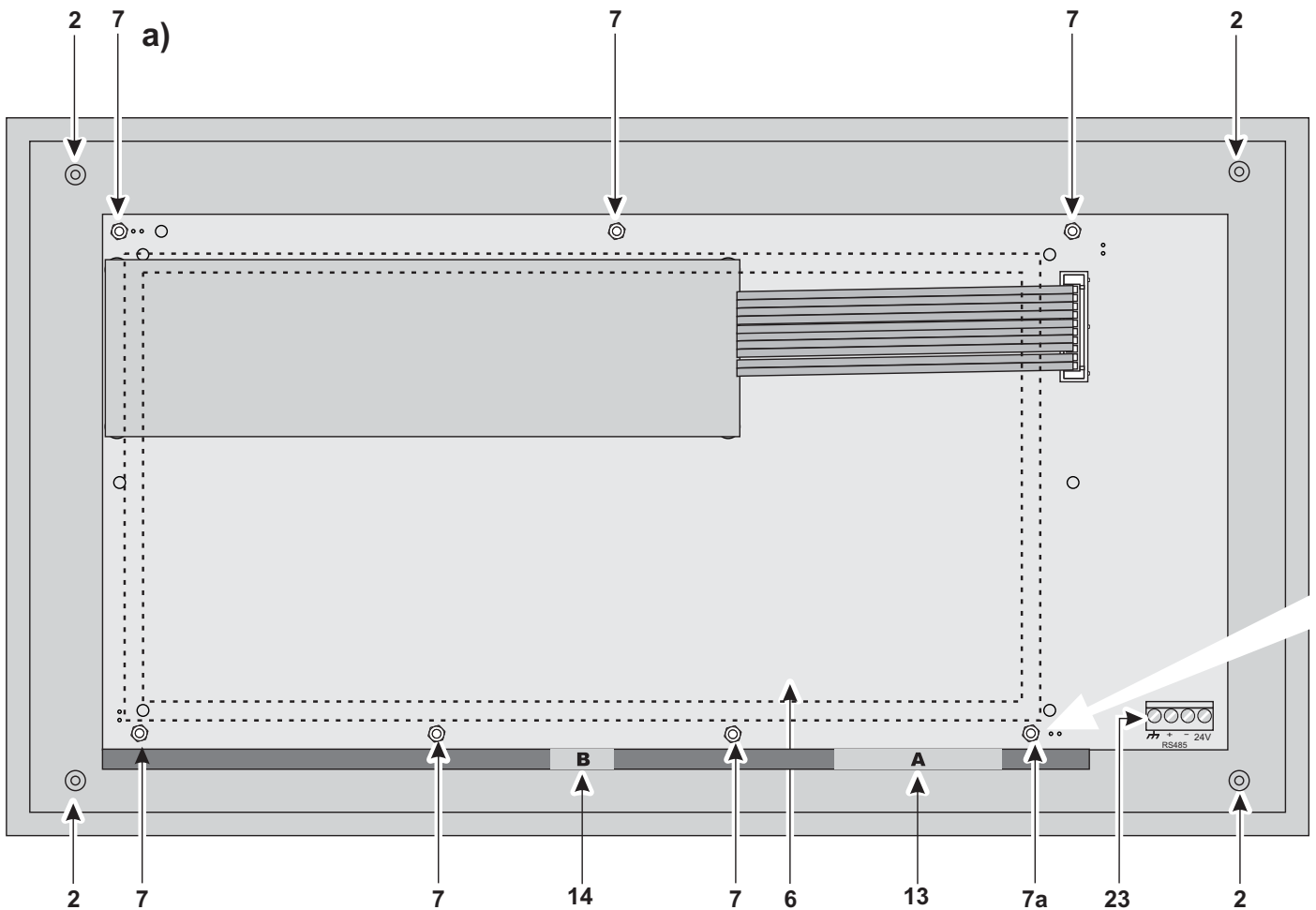

Figure 3 Configuration of the FC500REP Repeater **a)** frontplate (inside view); **b)** backplate.

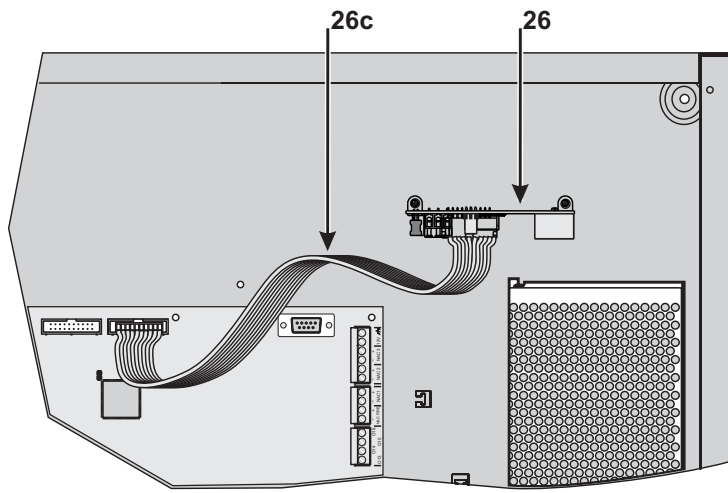
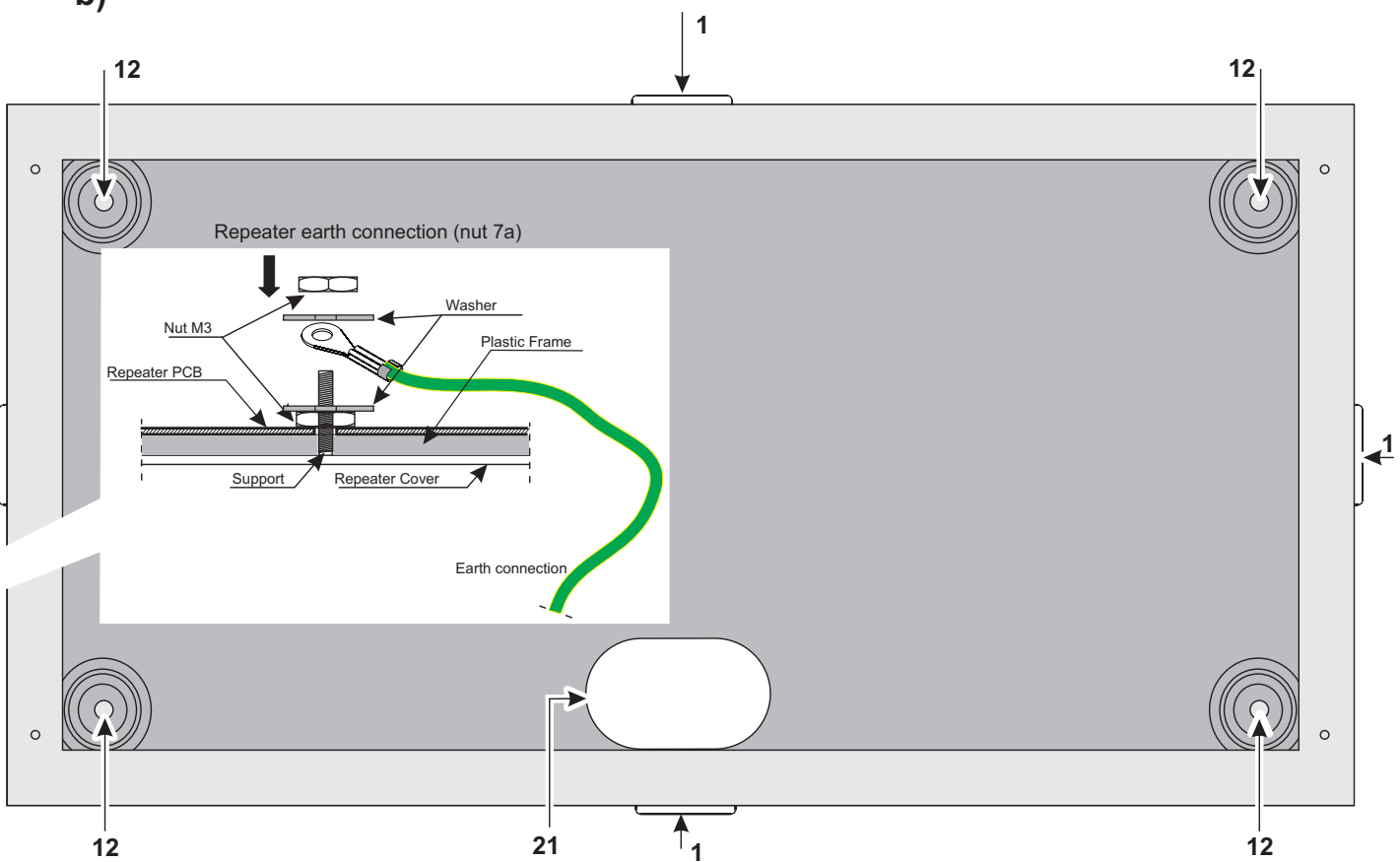



Figure 4 FC500IP board connection with the motherboard via the flat cable.

| P. | Description |
|----|------------------------|
| 24 | FC500PS Telecom Module |
| 25 | Loudspeaker |
| 26 | FC500IP board |

| P. | Description |
|-----|--|
| 26a | Connection FC500IP with PCLINK cable ,see note*(2) |
| 26b | Power FC500IP,see note*(2) |

b)



| | |
|-----|--|
| 26c | Connection FC500IP with Flat cable, see note*(2) |
| 27 | Mains indicator LED (switching power supply) |
| 28 | Switching-power-supply anchor hole |
| 29 | Switching-power-supply output voltage control input (connected at factory) |
| 30 | Fine trimmer for the Switching-power-supply output Voltage |
| 31 | Auxiliary power-supply terminals (27.6 V) |
| 32 | Mains power terminals (230 V / 50 Hz) |
| 33 | Switching-power-supply screws |
| 34 | Switching-power-supply fuse — protects against overload: -BAQ140T24 = F 4A 250V |
| 35 | Cable: connects the Switching power supply to the Main board (connected at factory) |
| 36 | Switching-power-supply anchor |
| 37 | Switching-power-supply closure rivet |
| 38 | Jack for the User interface board |
| 39 | Microprocessor |
| 40 | RS232 Serial Port |
| 41 | Terminal board |
| 42 | Terminal board |
| 43 | Jack for the thermal probe |
| 44 | Jack for the BAQ140T24 Switching power supply |
| 45 | Battery output voltage control panel (connected at factory) |
| 46 | RS485 terminal board |
| 47 | Jack for Extinguishment Module (Future use) |
| 48 | Jack (Future use) |
| 49 | Jack (Future use) |
| 50 | Jumper for Earth Fault (Leakage to Earth) signalling (Default ) *(1) |
| 51 | Microphone |

*** NOTE (1)**

Before connecting the Fire control panel to PC for the PC programming phase, remove the jumper **50** () of main board.

After the programming phase is finished, replace the jumper otherwise the Earth fault (Leakage to Earth) will not be detected.

| P. | Description |
|----|---|
| 52 | Jack for the connection between User Interface board and the Main board |
| 53 | Buzzer |
| 54 | Control Panel Backplate |
| 55 | 38Ah Batteries Backplate |
| 56 | Connecting Threaded tube |
| 57 | Nuts on Control Panel Backplate |
| 58 | Nuts on 38Ah Batteries Backplate |
| 59 | 12V 38Ah Batteries (accessory item) (see Figure 16) |

 *(2) If you connect the FC500 IP board with the motherboard via flat cable (26c) (Fig. 4) the Digital Communicator function will be activated. If the Digital Communicator function only is requested the PCLINK cable (26a) and the cables for board power are not necessary (26b) (see Figure 4). If both Digital Communicator than PC interface functions are requested the flat cable and the PCLINK cable are necessary, but not the power connection (26b).

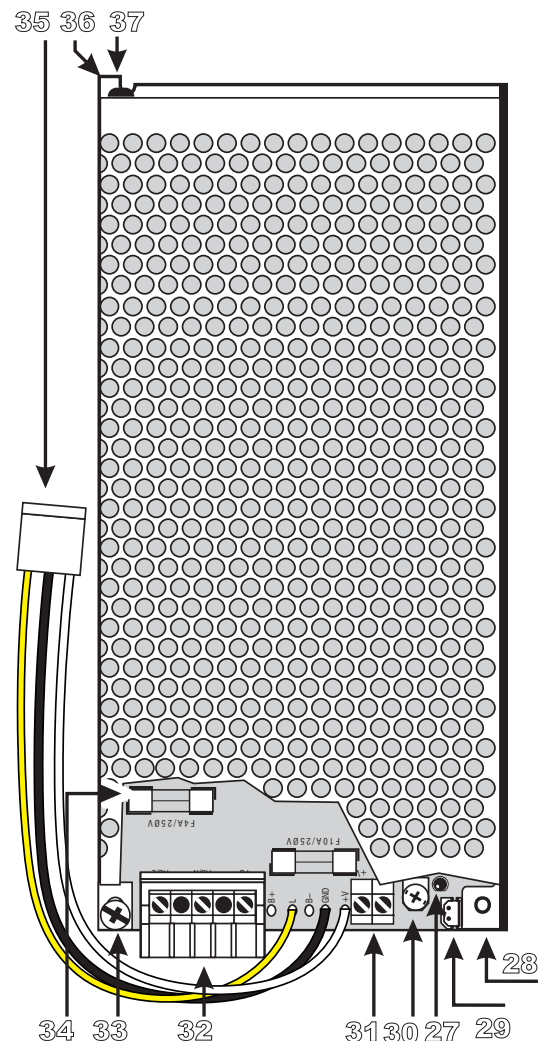

Figure 5 BAQ140T24 Switching-power-supply

LEDs and KEYS Labels

To insert the LED and Keys Labels (supplied) in the User Interface (see Figure 2, parts 13 and 14) work through the following steps:

- 1) Remove the screws **2** and open the Control panel or Repeater FC500REP (see Figure 3).
- 2) Corresponding the **A** or **B** (in the overlay) insert the relative LED and KEYS Labels (see Figure 1, parts 3 and 4);
- 3) check the right position (Figure 1) and then secure the Control panel or the Repeater FC500REP.

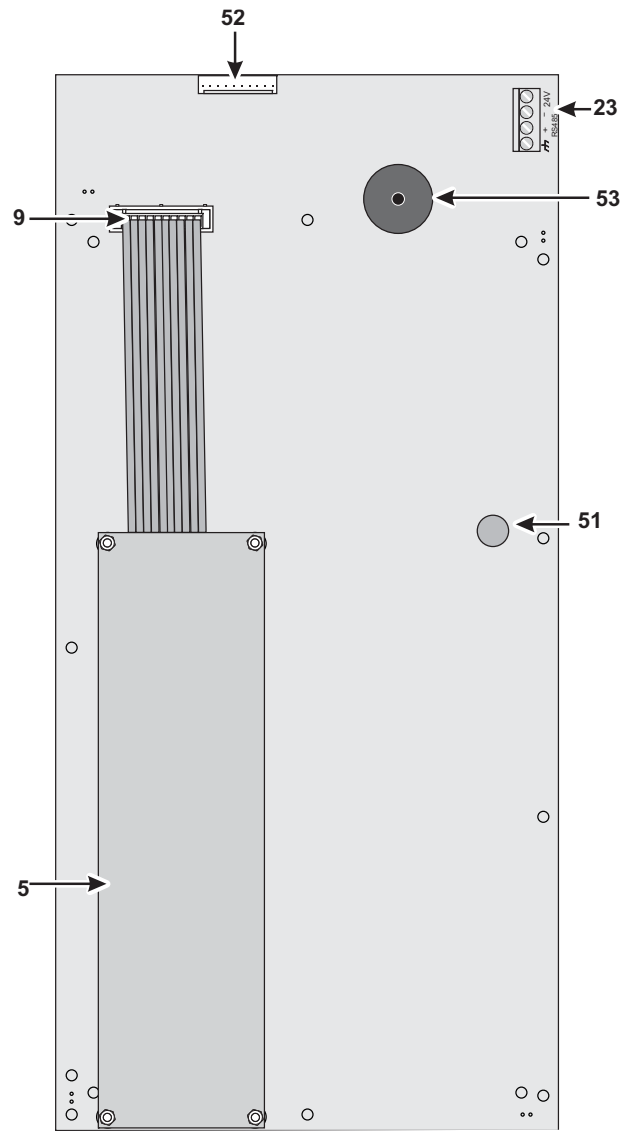

Figure 6 Parts: User interface-LCD board

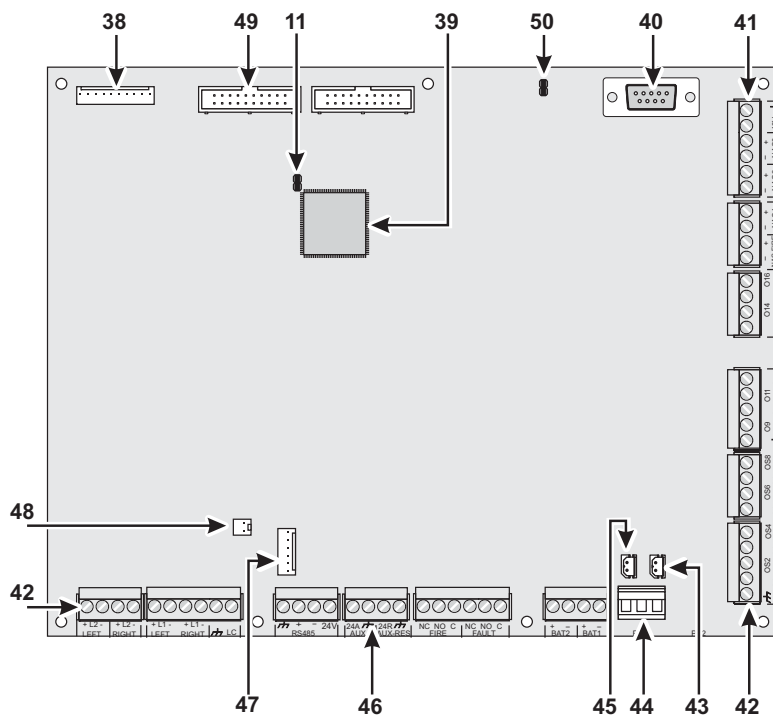

Figure 7 Identification of the parts: a) Main board .

Description of the Control keys

☞ **Test, Silence Buzzer and Evacuate** Control keys *ONLY* can be activated without password (access level L1), all the others Control keys can be activated with password (access level L2 and L3)

Lamp/Buzz/Test See table 4

Silence See table 4

Investigate See table 4

Silence Buzzer See table 4

Reset RESET will stop Alarm, Prealarm, Warning and FAULT conditions. Access to this command is limited to authorized personnel only (installer or user code PINs). The system will reprocess any alarm, prealarm, warning or fault signal which is not cleared by RESET operations. Command keys cannot be used when RESET is running.

The repeaters FC500REP can be RESET by the installer or user code PINs.

Evacuate See table 4

F1, F2, F3, F4 See table 4

| KEY | DESCRIPTION |
|-----------------------|---|
| Lamp/Buzz Test | <i>This key can be used to test the buzzer and LEDs . If this key is pressed (when the Control panel is functioning as intended), all the LEDs will glow and the buzzer will emit a continuous beep.</i> |
| Silence | <i>This key can be used to restore the Silenceable outputs to standby status. Silence status will be held until the Silence key is pressed again in Day Mode, or if the Control panel is operating in Night Mode, until the Night mode Silence time expires or until a new Alarm/Trouble condition is detected.</i> |
| Investigate | <i>This key can be used to refresh the “PreAlarm Time”: if this key is pressed during “PreAlarm”, the remaining PreAlarm time will be increased with the programmed “Recognition delay”.</i> |
| Silence Buzzer | <i>Key to silence the local buzzer of the control panel: the buzzer will be operating every time a new event will be activated</i> |
| Reset | <i>This key can be used to reset the Fire detectors and restore all outputs to standby status (Supervised/Silenceable outputs, NON-Supervised/Non-Silenceable outputs and Alarm zone outputs)</i> |
| Evacuate | <i>key to activate the evacuation: if this key is pressed for over 2 seconds, the system will generate an alarm.</i> |
| F1, F2, F3, F4 | <i>Function keys of the Display; their function will be various according to different screen of display</i> |

Table 4 Description of the keys

 **Installation of this system must be carried out strictly in accordance with the instructions in this section, and in compliance with the local safety regulations in force.**

To install the control panel work through the following steps:

- Choose suitable mounting locations for the Control panel, detectors, fire warning and fire control devices.
- Lay the cables between the Control panel and the system peripherals.
- If necessary, install any accessory modules.
- Before mounting the Control panel to the wall, insert the LED and Keys Labels (supplied) in the Interface User (see pag.17).
- Carry out the necessary connections, leaving the power-supply connection until last.
- Program the Control panel in accordance with the instructions in the “PROGRAMMING” section.
- Test the entire system (Control panel, detectors, fire warning and fire control devices).

 *Accessory Modules should be installed before mounting the Control panel to the wall.*

Installing accessory boards

 **Ensure that the Control panel power supply (Mains and Batteries) has been disconnected before installing any accessory Modules.**

Installing FC500REP Repeaters

Repeaters can be wall mounted, or flush mounted to an **ave® BL08** outlet box (or similar).

Work carefully through the following steps.

1. Lay the connection cables (refer to “Connecting Repeaters”).
2. Remove the screws **2** (see Figure 3) and open the Repeater FC500REP.
3. If you are **flush mounting** the Repeater, go to step **5**. If you are wall mounting the Repeater, drill the anchor screw holes **12**.

4. Pull the wires through the wire entry **21**, then, using the anchor screws, secure the Repeater to the wall.
5. Complete the connections to the terminal board **23** of the RS485 Interface, as described in the “Connecting Repeaters” section.
 - Connect the earth wire to the threaded support 7a on the cover, as illustrated in Figure 3.
6. Set the Repeater Address.

Installing the FC500PS e FC500IP board

Please refer to the dedicated manuals.

Installing the FC500 Slave control panel

See "Installing the Control panel paragraph".

Installing the Control panel

Work carefully through the following steps (see the Figures 1, 2 and 3).

1. Remove the screws (**2**) and open the Control panel.
2. Drill the anchor screw holes.
-  **Check for water pipes and electrical wiring before drilling.**
3. If necessary, using a hammer or similar tool, remove the surface conduit wire knockouts **1**.

 *The cable conduit union with the case must be secured by **HB Flame Class** (or higher) lock nuts.*

4. Pull the wires through the chased wire entry **21** then, using the anchor screws, secure the backplate to the wall.

Description of the Terminals

This section describes the Control panel terminals.

■ Main Board terminals

+L1-/LEFT (+)Loop 1-Positive signal, left side.
(-)Loop 1-Negative signal (return), left side.

+L1-/RIGHT (+)Loop 1-Positive signal, right side.
(-)Loop 1-Negative signal (return), right side.

+L2-/LEFT (+)Loop 2-Positive signal, left side.
(-)Loop 2-Negative signal (return), left side.

+L2-/RIGHT (+)Loop 2-Positive signal, right side.
(-)Loop 2-Negative signal (return), right side.

 Each Loop supports 250 (Analogue detectors, Input modules, Conventional Zone modules, Manual callpoints, Output modules and Sounders). In all the control panel supports up to 500 devices with 2 Loop.

LC Conventional Input Line - Supervised and Bypassable (Disabled) — This line supports 30 conventional fire devices (Optic Smoke detectors, Heat detectors, Manual callpoints).

Connect terminal **[LC]** to ground terminal [$\overline{\text{GND}}$] using a 3900 ohm resistor (orange-white-red). A 680 ohm resistance (normal value for Fire detectors) parallel to the 3,900 ohm resistor will activate the programmed actions and preset times of the Conventional Line outputs and the Non-supervised output (terminals NC, NO and C).

 The Conventional Line supports 30 Conventional detectors. **ATTENTION: DO NOT connect more than 500 detectors and/or manual call points to each main PCB.**

[$\overline{\text{GND}}$] Negative.

485 Serial Bus Terminals for FC500REP repeater panels (maximum 8) and FC500 as Slave panels (maximum 7). Serial bus terminals [+] and [-]; 27.6 V power voltage terminals [$\overline{\text{GND}}$] and [24V].

AUX Auxiliary power 24 V (0.5A max) Power supply to devices that operate at 24 V (powered by the standby batteries):

- Positive (27.6 V) on terminal [24A];
- Negative on terminal [$\overline{\text{GND}}$].

AUX-RES Auxiliary power 24 V (0.5A max). The system will interrupt power from terminal [24R] during Reset. Power supply to devices that operate at 24 V (powered by the standby batteries):

- Positive (27.6 V) on terminal [24R];
- Negative on terminal [$\overline{\text{GND}}$].

[NC][NO][C] FIRE Non-supervised **fire** output. Dry contact relay for non-supervised devices:

- During standby status — terminal **[C]** closes to terminal **[NC]**;
- In the event of fire — terminal **[C]** closes to terminal **[NO]**.

[NC][NO][C] FAULT Non-supervised **fault** output. Dry contact relay for non-supervised devices:

- During standby status — terminal **[C]** closes to terminal **[NC]**;
- In the event of fault — terminal **[C]** closes to terminal **[NO]**.

 *EN54-2 certification applies ONLY when, FAULT output is not J (EN 54-1) type, therefore this output MUST NOT UTILIZED to manage Fault transmission devices.*

+BAT2- Terminals to connect the batteries inside the FC500 control panel (see Figure2).

+BAT1- Terminal to connect remote batteries or Power supply.

PS1 BAQ140T24 power supply first connector.

PS2 BAQ140T24 power supply second connector.

OS1...OS8 Programmable, Silenceable, Bypassable (Disabled), Supervised Outputs.

These are normally-open terminals (open-collector) which will close to ground, when the connected event becomes active, and will remain in this state until the generating event has ended (so after a manual reset or a fault restore).

- These outputs can be bypassed via the DISABLE menu.

Connect an **EOL 27.000 ohm resistor** between terminals [OS] and [$\overline{\text{GND}}$] of these outputs. This will allow the control panel to detect and signal when the outputs are shorted and/or open.

 **NOTE:** The **EOL resistor** must be connected to the last device on the Supervised output. Connect a diode (1N4002 or 1N4007) in series to the devices connected to these outputs.

O9...O16 Programmable, Silenceable, Bypassable (Disabled) NOT Supervised outputs — These are normally-open terminals (open-collector) which close to ground when the connected event will active. These terminals will remain closed to ground even after the generating event has ended. These outputs can be forced to standby (Not programmable polarity) by resetting the control panel.

-NAC FIRE+ Type C output (EN54-1). - Silenceable, Bypassable (Disabled), Supervised — Terminals for supervised devices activated by positive (24 V):

- During ALARM status — positive (27.6 V) on terminal [+]; negative on terminal [-].
- During STANDBY status — negative on terminal [+]; positive (27.6 V) on terminal [-].
- This output can be bypassed via the DISABLE menu. ALARM status will activate this non-programmable output.

[12V] [↗] Auxiliary power 12 V . Power supply to devices that operate at 12V (powered by the standby batteries and protected by self recover termic fuse):

- Positive (13.8 V) on terminal [12V];
- Negative on terminal [↗].

Max current on terminal [12V] must not exceeded 200mA.

NAC1 NAC2 and NAC3 Supervised/Silenceable/Bypassable (Disabled) Programmable Alarm Outputs.

These Outputs are for the Alarm signalling devices.

Operating principles:

- in Standby status, these Outputs will be INACTIVE (read on for details);
- Output INACTIVE: negative pull-down to 0 V on [+] terminal; positive pull-up to 27.6 V on the [-] terminal.
- Output ACTIVE: positive pull-up to 27.6 V on the [+] terminal; negative pull-down to 0 V on the [-] terminal.
- NAC1, NAC2 and NAC3 will restore to standby when the Control panel Resets.
- NAC1, NAC2 and NAC3 can be Silenced (forced to standby).
The NAC Outputs will hold standby status for the programmed Silence Time. If Alarm conditions are present when the programmed Silence Time expires, they will re-activate.

⚠ NAC1, NAC2 and NAC3 accept devices that operate within SELV limits ONLY.

⚠ EN54-2 certification applies ONLY when, NAC1, NAC2, NAC3, OS1, OS2, OS3, OS4, OS5, OS6, OS7, OS8, O9, O10, O11, O12, O13, O14, O15, O16 and RELAY FIRE outputs are not C, E, J, G (EN 54-1) type, therefore these outputs MUST NOT UTILIZED to manage Fire Alarm devices and/or Fire Alarm Transmission devices and/or Fire Fault Transmission devices and/or Automatic Fire Alarm Systems.

The System Wiring

⚠ Use shielded cable only for all connections, with one end of the shield connected to the Control panel negative terminal and the other left free.

⚠ High Voltage leads (230 V) must be bunched separately from Low Voltage leads (24 V). All leads must be bunched in such a way as to avoid contact with other wiring and components.

■ Connecting Addressable Analogue Devices

The control panel has 2 loops for addressable analogue devices.

Each loop supports 250 addressable analogue fire detectors and an analogue devices (Input modules, Conventional Zone modules, Output modules).

⚠ Every detector and every module connected to a loop must be assigned a DIFFERENT address (using the special Loop Service Tool FC490ST) from the other detectors on the same loop.

You can use 2 or 4 wires for the loop connections.

NOTE: The loop connection type must be specified during the programming phase.

Figure 9(1) illustrates the 2-wire connection to Loop2.

Figure 9(2) illustrates the 4-wire connection to Loop2.

⚠ Whatever the type of connection performed, make sure that any short circuit or open circuit in the wiring does not lead to the loss of more than 32 detectors. An insulator should be fitted at least every 32 detectors

⚠ If the connection is 2-wire connection type, connect on the left

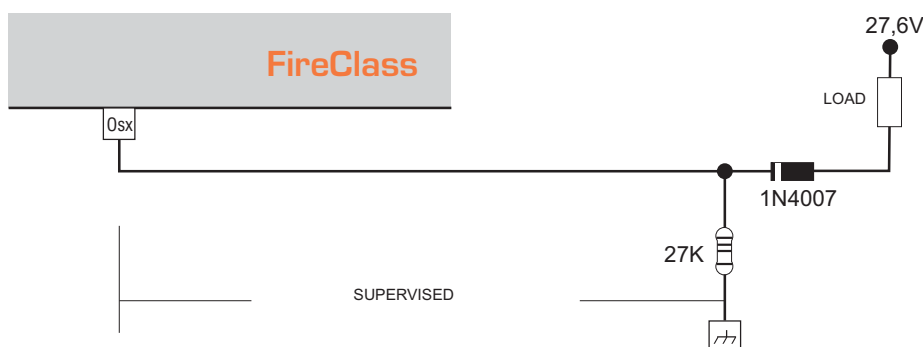

Figure 8 OSx Outputs connecting

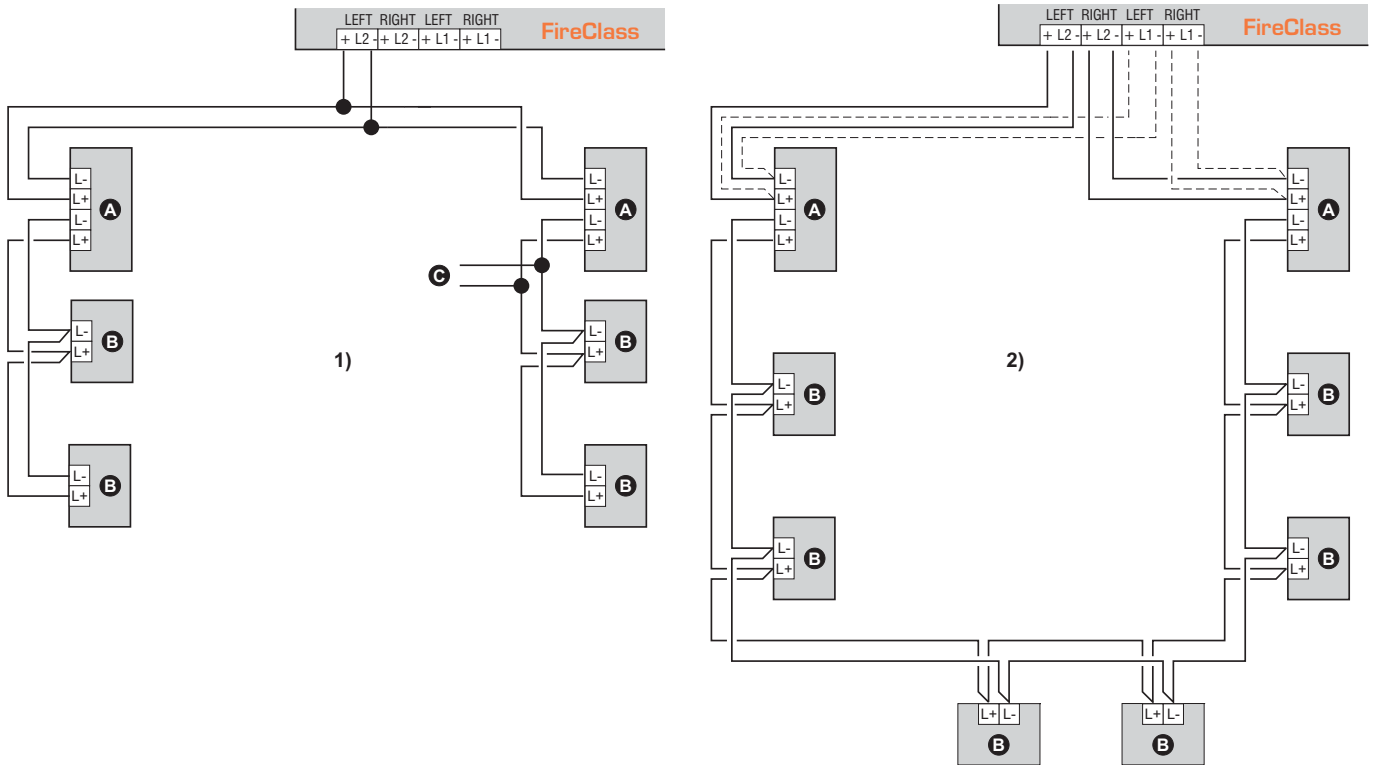

Figure 9 1) Wiring diagram of a 2-wire connection - 2) Wiring diagram of a 4-wire connection: a) Insulators; b) Compatible analogue devices (Fire detector, Input modules, Output modules, Conventional Zone modules, Manual callpoints); c) T connection.

■ Connecting Conventional Devices

Connect Conventional devices to terminals [↗] and [LC]. **Fire detectors and Manual call point.**

Connect the Conventional Fire detectors in parallel to terminals [LC] and [↗].

The resistor (3,900 ohm) connected to these terminals

must be moved to the terminals indicated in the instructions of the last device on the Conventional Line (see figure 9a).

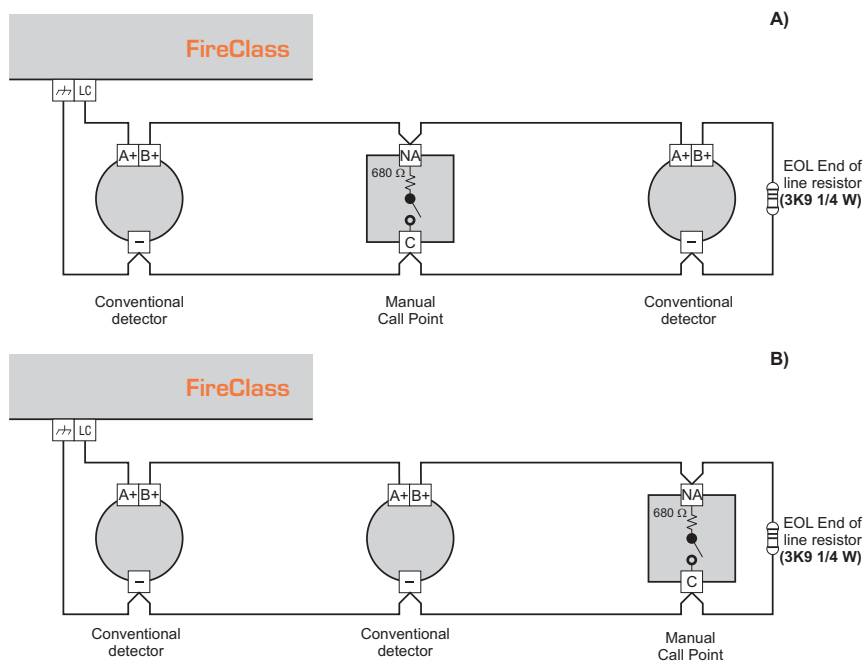

Figure 10 Wiring diagram of Conventional device connections

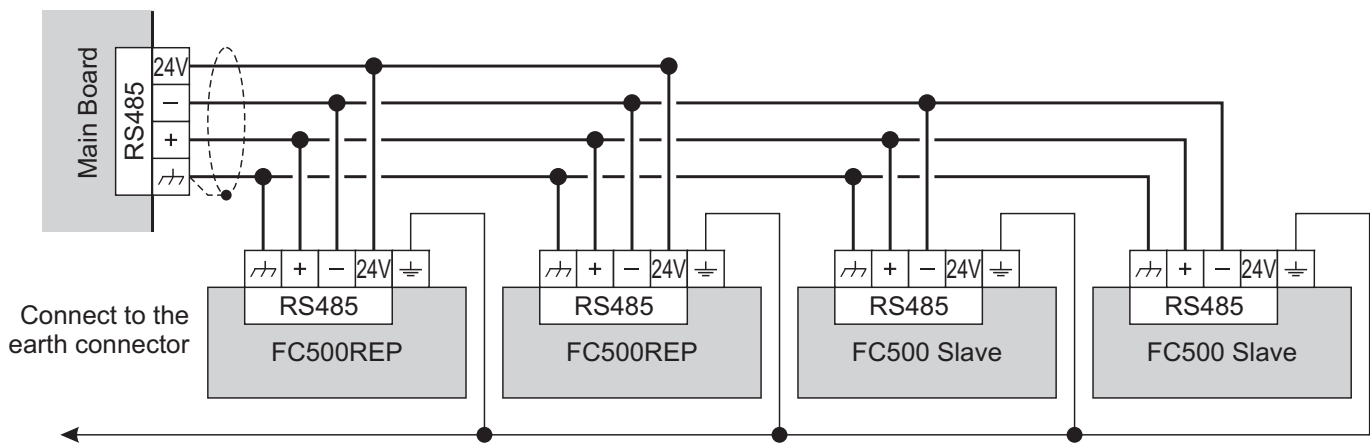

Figure 11 Wiring diagram of two FC500REP Repeaters and two FC500 Slave Control panels connected to the RS485

■ Connecting Repeater and Slave Control panel

An example of how to connect two FC500REP repeaters and two FC500 SLAVEs is shown in Figure 10.

The RS485 port of the FC500 (terminals [↻], [+], [-] and [24V]) accepts up to 8 FC500REP repeaters and up to 7 FC500 SLAVEs, so a panel will be configured as a "Master" control panel while the others seven will be configured as "Slave" control panel; the eight Repeaters will be the Repeaters of the "Master" control panel.

👉 Assign an address to FC500REP repeaters (see the procedure "Programming from the Panel" page 51).

Terminals [+] and [-] supply the power (27.6 V) to the repeater panels (see figure 10,11).

When a mains fault occurs, the Repeaters considerably decreases the absorbed power, switching off the LCD display backlighting (the LCD display backlighting switches on again, for 20 sec. when a key will be pressed). But the absorption of the Repeaters connected to the control panel, will contribute to run down the backup batteries, and so the decrease of the Stand-by supply time of the system.

When one control panel only is in the system all the Repeaters must be supplied by the control panel itself, unless a Power supply Station is in the system.

When several Control panels are in the system, the Repeaters supply Load can be shared between these Control panels (see Figure 11).

👉 The control panel [24V] terminals must not be connected between them, because the switching Power supply cannot work in parallel and the entry in protection status (OFF) can be produced with the effect of overloading the switching Power supply still working.

Use shielded cable only, with one end of the shield connected to the "Master" Control panel Negative terminal and the other left free; the continuity, between several segments of connection must be secured (see Figure 11).

■ Connecting Output Devices

The control panel has 8 supervised outputs, 8 NON supervised outputs and 4 Bell outputs (supervised and silenceable) .

👉 **NOTE:** Output devices can be connected to the loops by means of Output modules.

■ Bell Outputs

The Bell outputs are indicated by the letter NAC and their address number.

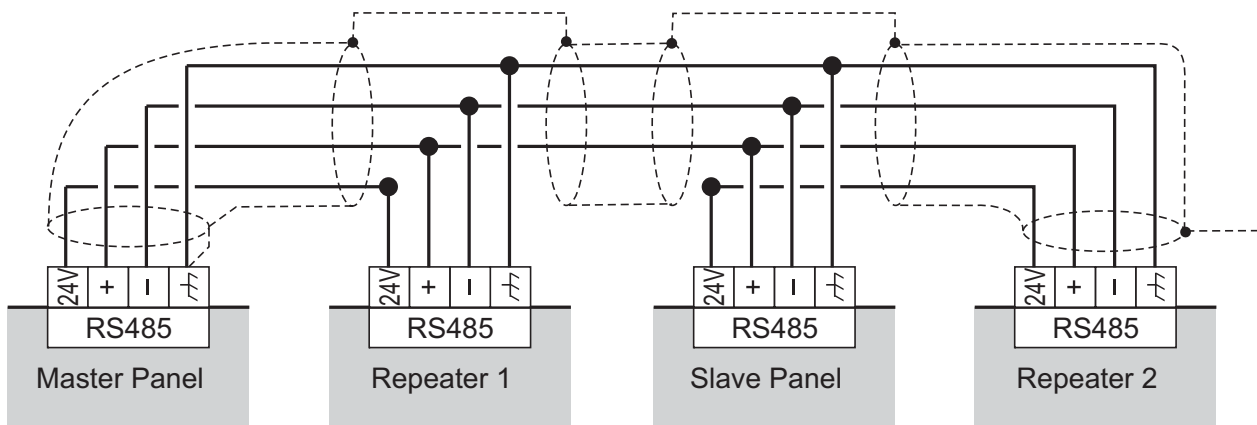

Figure 12 Network connection example: the Repeaters supply load is shared on several Control panel. In this case the "Repeater 1" is supplied by "Master" panel while the "Repeater 2" is supplied by "SLAVE" control panel.

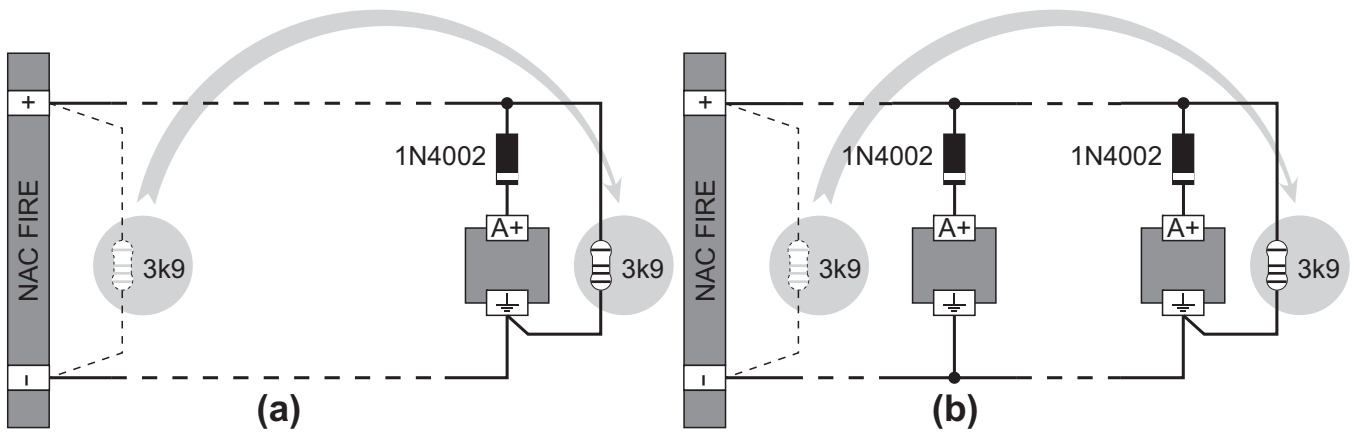

Figure 13 Wiring diagram of the connection of a single device (a) and several devices (b) to Bell outputs (device activated by positive (27.6 V) on terminal [A+]).

☞ The NAC1, NAC2 and NAC3 Bell Outputs are Programmable, Supervised, Silenceable, Bypassable (Disabled).

☞ The terminal marked "-NAC FIRE +" is a Bell output (C type, EN54-1), Supervised, Silenceable, Bypassable (Disabled) but Non-programmable. This output will activate when the Control panel goes into Alarm status.

The Bell outputs can be forced to standby status by means of the SILENCE button. Once an alarm has been acknowledged, you can silence the audible signalling devices and leave the visual signalling devices active until the alarm conditions cease.

For example, a connection similar to the wiring diagram in figure 12 will activate the Flasher, the Bell and the visual and audible signalling device of the Self-powered Siren in the event of an alarm.

Using the **SILENCE** button will stop the horn but not the flasher, which will continue to signal Alarm status until the **RESET** button is pressed.

Connecting a Power Supply

☞ The power circuits of this Control panel comply with the EN54-4 standard.

⚠ In order to comply with the Safety regulations in force, the Mains must be equipped with a bipolar isolating device for protection against over voltage and short-circuit to Earth (e.g. automatic isolating switch).

This Control panel is powered from the Mains (230V/50 Hz) through a Switching power supply, located inside the case. The **FC510** and **FC520** Control panel provide housing for two 12 V, 17 Ah maximum batteries; moreover, the **FC510** and **FC520** Control panel can be connected to two 12 V, 38 Ah in an external metal box (see Figure 15) for power during Mains failure.

The non-volatile memory will hold the programmed data at all times.

In the event of Mains failure, the:

- GREEN Mains LED will turn OFF
- AMBER Mains LED will turn ON

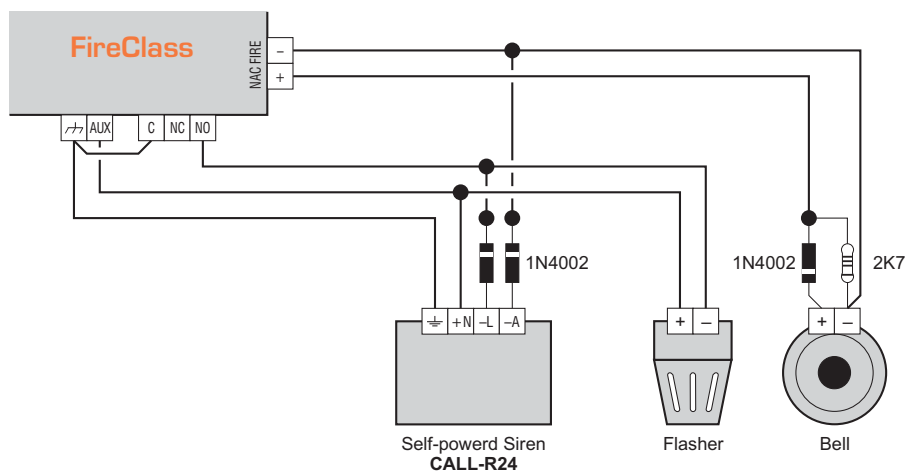

Figure 14 Wiring diagram: NON-silenceable and Silenceable Output connections

The Control panel will monitor the batteries at all times, (refer to **Static Test** and **Dynamic Test**).

Static Test The **Static** Test monitors the battery charge during Mains failure. In the event of **Low battery** status (below 22.8 V), the **Low Battery** LED will turn ON. If this occurs, the Mains power must be restored before the batteries empty, otherwise, the system will shut-down.

Dynamic Test The **Dynamic** Test monitors the operating capacity of the batteries. In the event of a Failed Test result (batteries do not meet the Test requirements), the **No Battery** LED will turn ON. If this occurs, the backup battery must be replaced immediately, otherwise, the system will be unable to function in the event of Mains failure (black-out).

Work carefully through the following steps to connect the Mains Supply.

1. Locate the backup batteries in the housing (see Figure 2, 3) .
2. Using the Jumper (supplied), connect the batteries in series.
3. Observing the battery polarity, connect the battery terminals to terminals BAT1 or BAT2 on Main Board (wires supplied).
4. **FC510-FC520** Use 17 Ah @ 12 V YUASA NP 17-12 FR batteries; or similar with case flame class UL94-V2 (or higher).
5. Connect the **Earth** wire to the [⊕] terminal on the terminal board **32**.
6. Connect the **Neutral** wire to terminal [N], and the **Line** wire to terminal [L] on the terminal board **32**.

 *The Control panel will reset on power up.*

 **DO NOT allow the power cable to cross over other wiring (see Figure 19a). The power cable must be routed as per Figure 19c and held firmly in place by a cable tie (see Figure 19b).**

■ Thermal Probe

This Control panel supports the **KST** thermal probe. The probe will optimize the battery charging process by regulating the charge voltage in accordance with the battery temperature.

Work carefully through the following instructions (refer to the figure 2):

1. Connect the probe **22** to the connector **43** on the Main board of the Control panel and the wire (supplied) between the connector **45** on Main Board and the connector **29** on the BAQ140T24 switching Power supply.
2. Attach the probe to one of the batteries, in such a way as to obtain optimum heat transfer.
3. Measure the Probe temperature.
4. Using the graph in Figure 17 and/or Table 5, find the value (in accordance with the battery temperature) that the output voltage of the Switching Power Supply will be based on.
5. Using the trimmer **30**, adjust the voltage on the terminal board **32** to the required value.

 **NOTE:** *to verify the battery efficiency, the PCB will measure the internal resistance. In order for this measure is not distorted, you should use only the cables supplied; cables that are longer and have an insufficient section may erroneously simulate the condition of inefficient battery.*

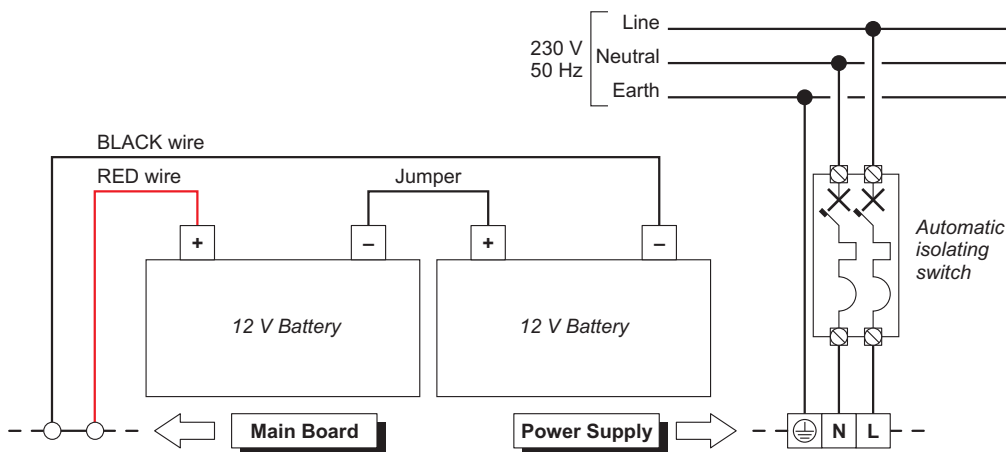

Figure 15 Wiring diagram for the power supply

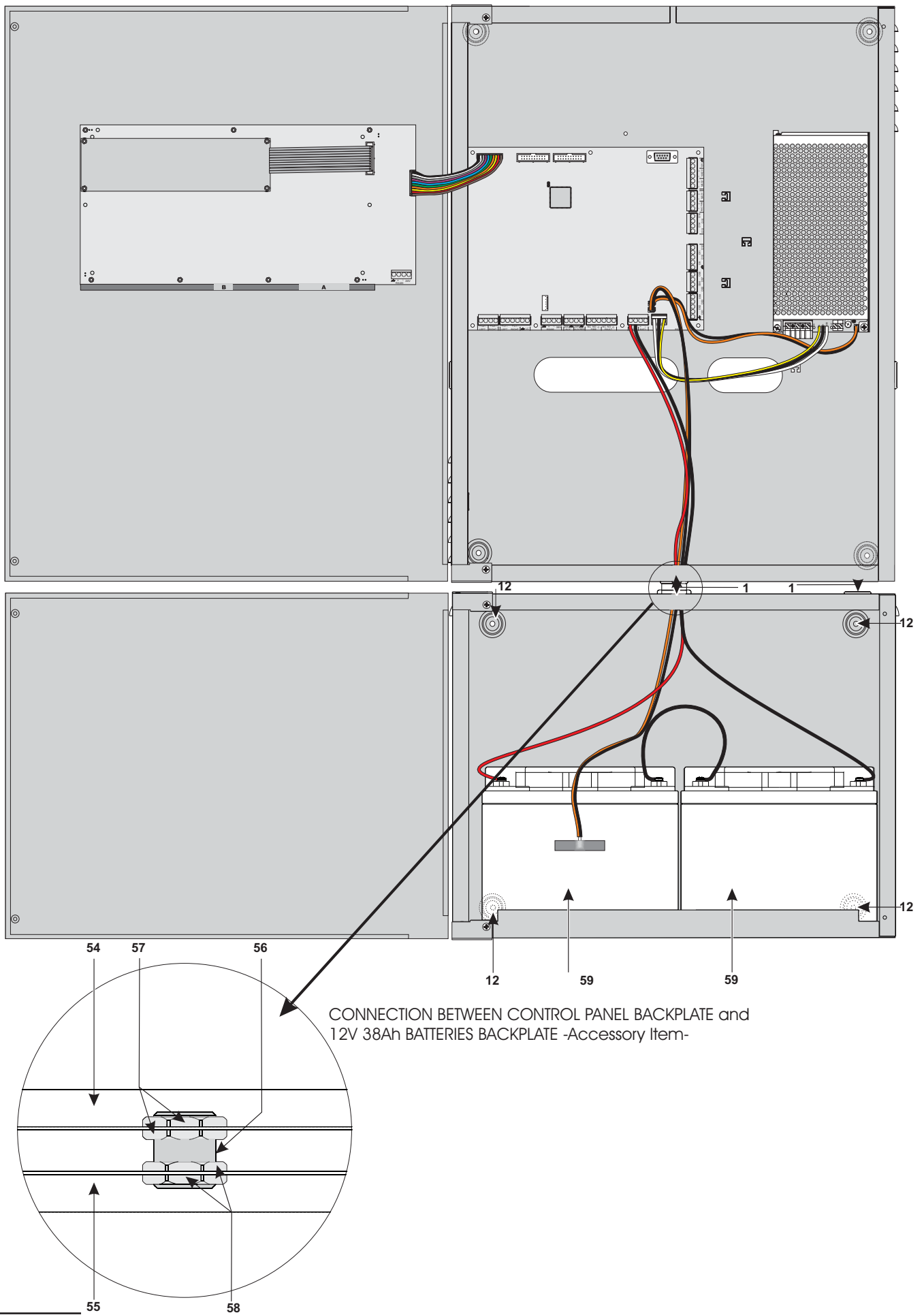

Figure 16 Control Panel and 38Ah Batteries metal Box connection (accessory item).

Installing the 38Ah battery metal Box

Work carefully through the following steps (see Figure 16).

1. Remove the screws (2) and open the metal box.
2. Drill the anchor screw holes.

 **Check for water pipes and electrical wiring before drilling.**

3. If necessary, using a hammer or similar tool, remove the surface conduit wire knockouts 1.
4. Secure the metal backplate to the wall

 *The cable conduit union with the case must be secured by **HB Flame Class** (or higher) lock nuts.*

Pull the wires through the chased wire entry 1 and connect them. See paragraph: Connecting a power supply.

Maintenance

The following operations must be carried out regularly.

A Using a damp cloth (DO NOT USE SOLVENTS OF ANY KIND), remove dust from the Control panel case.

B Using the **Lamp/Buzz/Test** key, check that the LEDs and buzzer are functioning properly.

C Ensure that the batteries are sufficiently charged and functioning properly. If not, replace them immediately.

D Ensure that all cables and connections are intact.

E Ensure that there are no unrelated objects inside the Control panel case.

 *Points **A** and **B** may be carried out by users. Points **C**, **D** and **E** must be carried out by qualified persons only.*

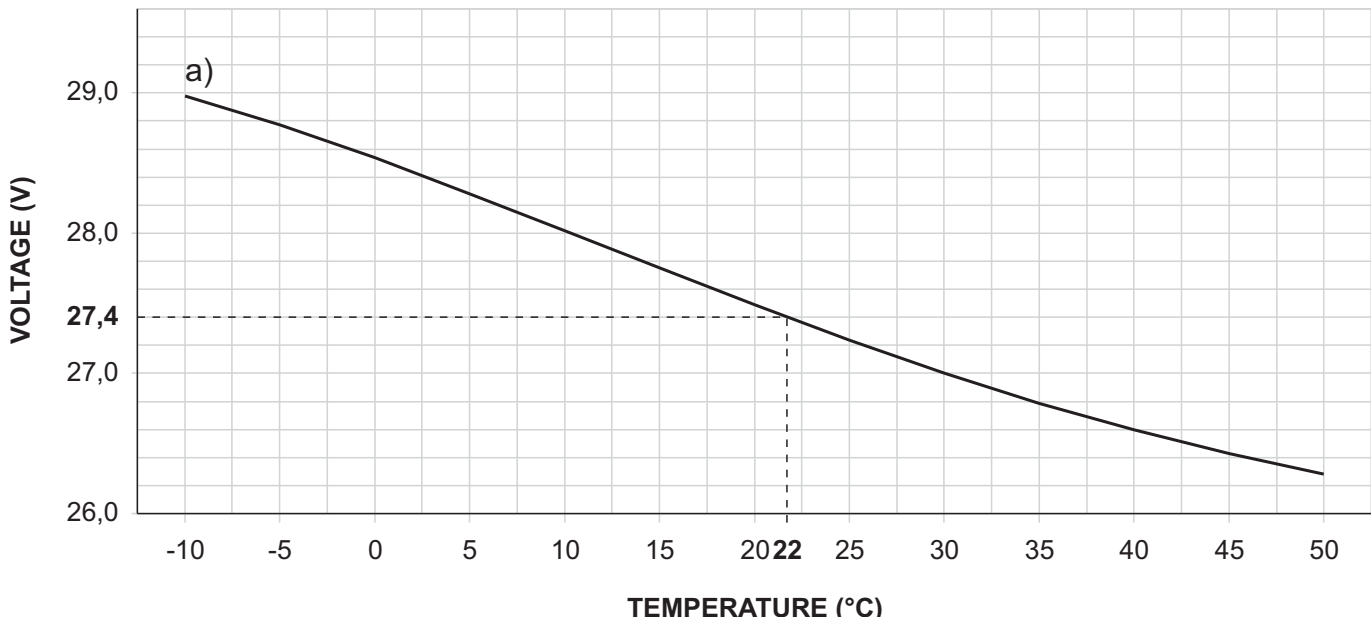

Figure 17 Switching Power Supply Output Voltage graph. To find the Output Voltage using the graph: — indicate the Probe temperature on the **TEMPERATURE (°C)** axis; draw a line from the temperature value point up to the curve **a)**; draw a line from the intersection point across to the **VOLTAGE (V)** axis; adjust the Output Voltage of the Switching Power Supply to the resultant value. For example, if the Probe temperature is 22 °C, the Output Voltage of the Switching Power Supply must be set at 27.4 V.

| TEMPERATURE (°C) | -10 | -5 | 0 | 5 | 10 | 15 | 20 | 25 | 30 | 35 | 40 | 45 | 50 |
|------------------|------|------|------|------|------|------|------|------|------|------|------|------|------|
| VOLTAGE (V) | 29,0 | 28,8 | 28,6 | 28,2 | 28,0 | 27,8 | 27,4 | 27,2 | 27,0 | 26,8 | 26,6 | 26,4 | 26,2 |

Table 5 Switching Power Supply Output Voltage chart. To find the Output Voltage using the chart: — select the nearest value to the Probe temperature on the **TEMPERATURE (°C)** row; read the respective value on the **VOLTAGE (V)** row; adjust the Output Voltage of the Switching Power Supply to the indicated value. For example, if the Probe temperature is 22 °C, the Output Voltage of the Switching Power Supply must be set at 27.4 V.

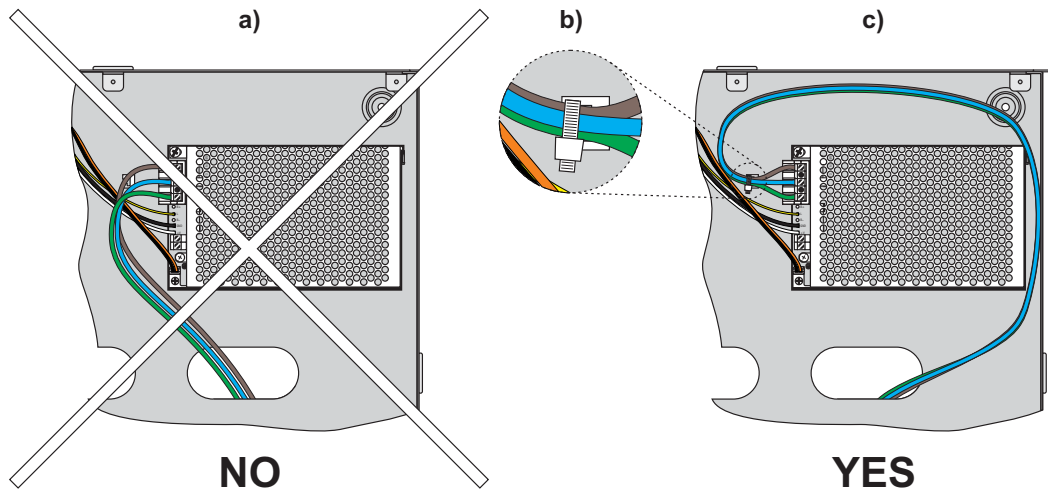

Figure 19

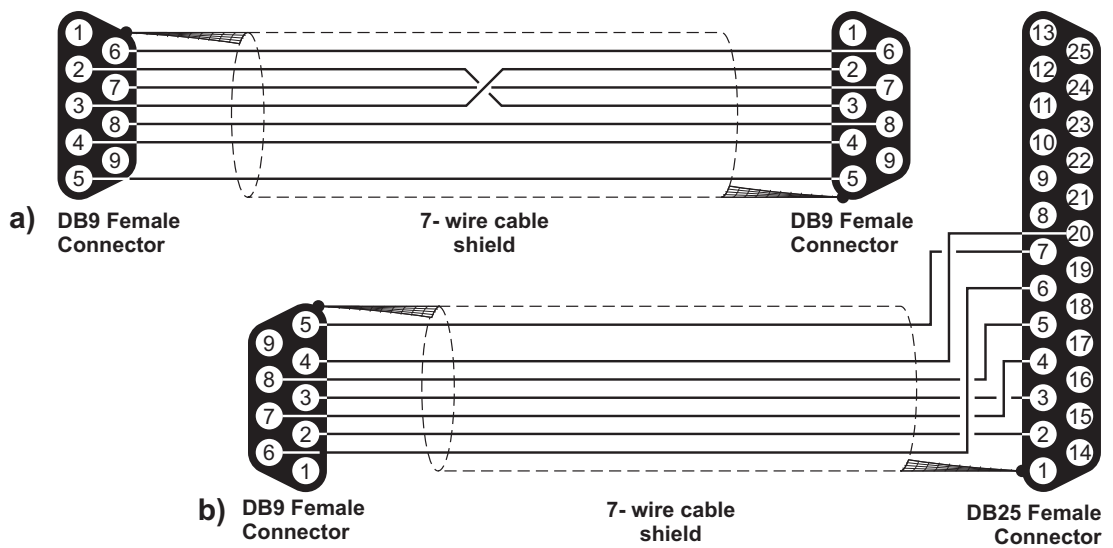

Figure 18 Wiring diagram for the serial link between the Control panel and PC

You can program this system from the Control panel or from a computer, using the **FireClass500** Software Console, inside the Bentel Fire Suite.

This section describes how to program the system from a computer. If you intend programming the system from the Control panel refer to the "PROGRAMMING FROM THE PANEL" section.

Introduction

The FC500 software console contains:

- **FC500 console** : the application to manage and program the FC500 series control panels.

Installation

Work carefully through the following steps to install the **FC500** software applications.

- Run the **Setup.exe** application contained in the **CdRom "Fire Suite"**.
- Select a folder for the FC500 software applications.
- Run as Administrator.

Select language

You can select the language of the FC500 Software, from the **Languages provided**.

To Select the application language:

- Run the **FC500 Software** application;
- Select **Options** from the **Main** window;
- Select **Language** from the drop-down menu to open a window with the language list;
- Select a language from the **Language** list;
- Click-on **✓ OK**,

The selected language will be immediately initialised.

 *At the first start up, FireClass Console software will ask to choose the language.*

Software window Look

To modify the look of the FC500 software window, click-on Key "Available Skin" in the left bottom of the Main window or click-on right key on the title bar. This option allow you to modify the look of the window in the offer range (see Figure 20).

Control panel connections

If you are using the Supervisory, Management, Downloading and Log Management functions, the control panel must be connected to your PC in local communication or remote by PSTN line, GPRS or LAN.

To connect the control panel in local:
(see note page n. 16)

Using a **CVSER/9F9F** cable (accessory item) or similar cable (see figure 18), connect the control panel serial port (refer to "PARTS IDENTIFICATION") to a serial port on your PC.

- Select the PC serial port from the **Option** menu (**Choose serial port**) and then Click-on **✓ OK**.
- For 25 pin serial ports, use an **ADSER/9M25F** adapter (accessory item) or make a cable as per figure 18b.

If the control panel is **not connected** to your PC when you start the communication, the following warning will be shown: "**Communication error! Check serial link**". If the serial port for the local communication is **invalid**, the following warning will be shown: "**Cannot open serial port**".

Main window

The FC500 Software opens on the **Main** window (see fig. 20). The following section describes the **File, Com-**

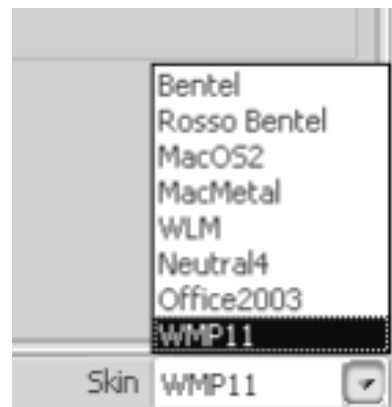

Figure 20 To modify the window look (Available skins).

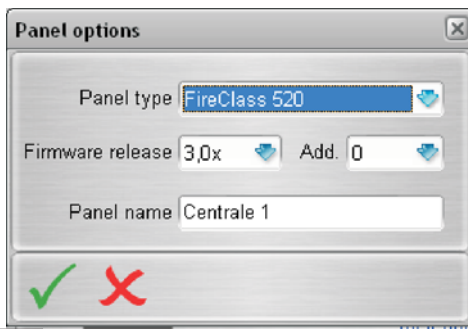

Figure 21 New panel window (Type of control panel)

unication, Options, DataBase, Mode setup and Help menus, in the top left-hand corner of Main window.

■ Icons description

Click-on this icon under "Panel 1" the window "New panel" will open, Figure 21. Here, you can choose the type of control panel, the Firmware Release, the control panel name and the possible address if more control panel are present in the system.

Description of the icons under "Panel 1"

- Click-on this icon and then confirm to restore the factory defaults.
- Click-on this icon to download the programming (via serial link) to the connected control panel.
- Click-on this icon to upload all the programming (via serial link) of the connected control panel.
- Click-on this icon to see the firmware version of MainBoard , Loop controller, User Interface, Repeater and FMI module.
- Clicking on the icon begins operation in Real Time, in other words it is possible to view the status of the FC500 control panel in real time and on a computer using the FC500IP module connected to the network or using the serial port.
- Click the icon to select the Real Time operating mode: using the FC500IP module (enter IP address) or using the serial port (select the port).
- Click-on this icon to add a new Loop expansion board.
- Click-on this icon to remove a Loop expansion board.
- Click-on this icon to open the Data customer window.
- Click-on this icon to insert-modify the Installer Password.
- Selected a stored customer, click-on this icon to delete the customer, after confirm: OK.

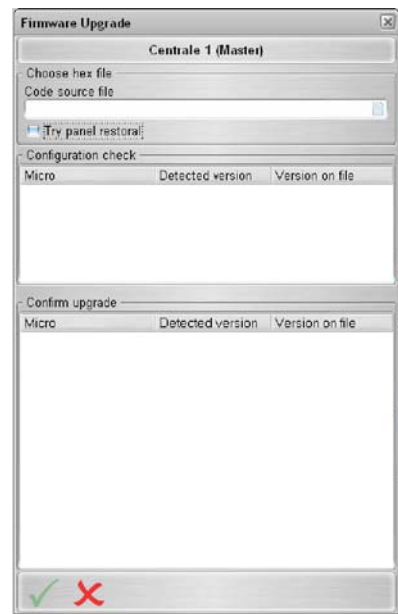

Figure 23 Firmware Upgrade window

- Click-on this icon, in a Master control panel, a window in Figure 21 will be shown. In this window, a Slave control panel can be inserted with a name and an address, the same programmed address from the user interface of Slave control panel (see Programming from the panel).
- Click-on this icon to remove the selected Slave control panel, after a request of confirmation.

■ File

The File options (New, Open, Save, Close, Export/Import configuration file, Exit) will allow you to manage customer account data.

New (New customer) The New option creates a New customer and restore the factory default to all programming parameters.

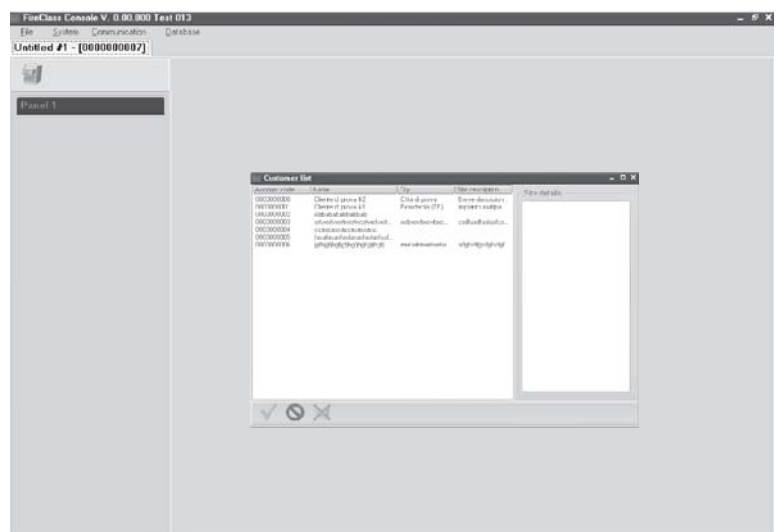

Figure 22 "Open" window .

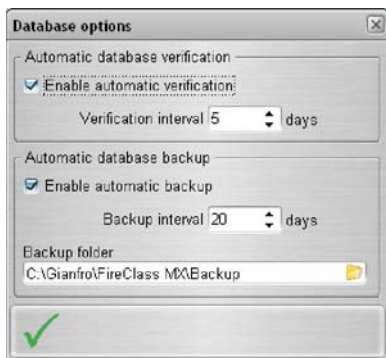

Figure 24 Database Options window.



Figure 25 "Maintenance" database window.

Open Click-on "Open", to retrieve customer data from the "Customer List" (see Figure 22). Click-on selected customer and after confirm: ✓ OK.

Save If a new customer is programmed or the exiting data customer are modified, click-on "Save" a new customer or the new configuration will be saved.

Close Click-on "Close", the selected customer will be closed.

Exit Click-on "Exit", the FC500 software will be closed.

Export configuration file: Click-on this option, all the data customer will be exported in a single file.

Import configuration file: Click-on this option, all the data customer will be imported from a single file.

■ Communication

In this menu: the option **Firmware Upgrade** only.

Firmware upgrade Click-on "Firmware Upgrade": the window (see figure 23) will be shown.

From a source file, this option allow you to do the Firmware Upgrade of all system interface: Mainboard, User interface, Loop controller.

■ Options

In this menu you find the options: **serial Port, Language and Realtime options** . See the previous paragraph: "Select language", "Control panel connections" and icon  "Realtime".

■ Database

The Database menu provides the following options: **Maintenance** and database **Options** .

Maintenance This option opens the window in figure 25 where you can check the database. If faults will be found, you can do the database rebuilt.

Options This option opens the window in figure 24, where you can program the delay between more database checks, and more database backup.

■ Mode setup

Click on **Mode setup** to set the operating mode of the software, installer or user and the communication mode: Normal or Real-Time Communication (see Help).

■ Help



Click on **Help** option; a technical support file will be opened. This application allows you the learning and the use of FireClass 500 Console software.

Devices programming

Click-on Control panel name, and than on Loop1 or Loop2, the devices programming window will shown (Figure 26).

 *Close Loop1 or Loop 2 name, in the round brackets () there is the Loop devices number.*

■ Description of the icons in the tool bar.

-  New Device: select new devices;
-  Remove device: remove the installed devices;
-  Copy device on clipboard: allow you to copy the devices data and after paste them in another customer.

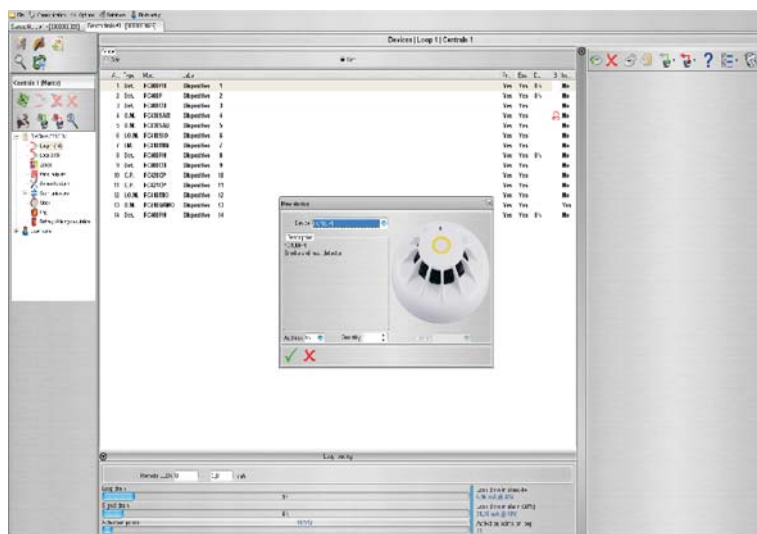







Figure 26 Devices programming window

| Detector Class | Typical application Temperature °C | Max. Application Temperature °C | Min.Static Response Temperature °C | Max.Static Response Temperature °C |
|----------------|------------------------------------|---------------------------------|------------------------------------|------------------------------------|
| A1 | 25 | 50 | 54 | 65 |
| A2 | 25 | 50 | 54 | 70 |
| B | 40 | 65 | 69 | 85 |
| C | 55 | 80 | 84 | 100 |
| D | 70 | 95 | 99 | 115 |
| E | 85 | 110 | 114 | 130 |
| F | 100 | 125 | 129 | 145 |
| G | 115 | 140 | 144 | 160 |

Table 6 Detector classification Temperature - Detector shall conform to one or more of the following classes: A1, A2, B, C, D, E, F o G . Manufacturers may optionally give additional information concerning the type of response exhibited by the detector, by adding the suffix S or R to the above classes.

Detectors, with a suffix **S** to their class, do not respond below the minimum static response temperature, even at high rates of rise of air temperature.



Detectors, with a suffix **R** to their class, incorporate a rate of rise characteristic, which meets the response time requirements for high rates of rise of air temperature even when starting at air temperature substantially below the typical application temperature (EN54-5:2000).

-  New device from clipboard: allow you to copy the devices data from a customer and after paste them in another customer.
-  Upload from board: to download the programming (via serial link) to the connected control panel.
-  Download to board: to upload all the programming (via serial link) of the connected control panel.
-  Print a text file; in this case, the list of devices fitted within the control panel loop.
-  Device's details: a further window allow you to see the points and the Outputs where the devices is enabled.
-  Select: allow you to select all present devices.

 If different devices have common programming parameters, you can use the multiple selection of the devices and assign the same parameters.

 You can see (view) the list of devices included in List or Grid, put the check.

Select devices Click-on **Panel 1**, select **Loop 1** or **Loop 2**, click on "new device" , the window in Figure 26 will shown: select the programming devices, enter a valid address, and after click-on  OK to put the devices in configuration. For others devices, repeat the same procedure.

Remove devices Select the device, therefore click-on "Remove device" , and confirm the choose  OK.

Loop Loading At the end of "Device programming window", Figure 26, there is a Loop Loading section. Here, the "Loop drain" and the "Signal drain" will be shown . On the right, the "Loop drain in stand by", the "Loop drain in alarm (50%)", and the "battery needed" will be shown.

 The remote LEDs may be entered in the calculation

The percentage shown in the "Loop drain in alarm (50%)" is the programmed value in "Battery calculation" an option of Configuration menu (see dedicated paragraph).

■ Parameters detectors programming

Click-on device in configuration, the relative programming window will shown (every device has the dedicated programming window).

For the detectors (see figure 26); in the **Multiple sources** section:

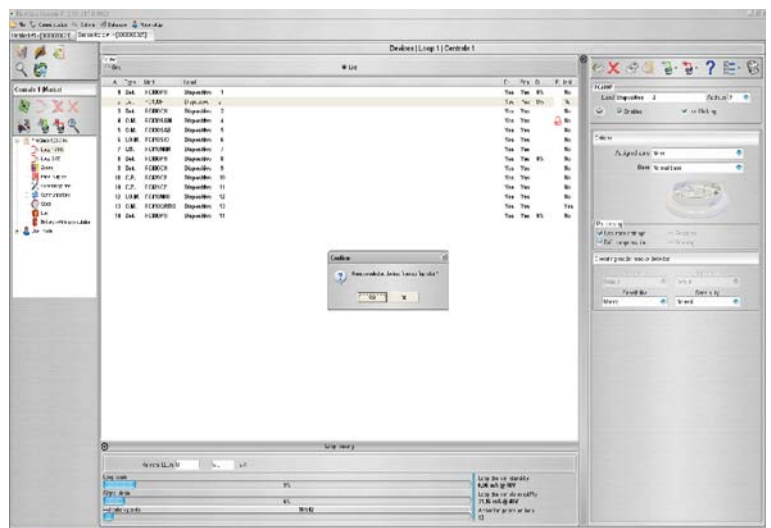

Figure 27 Detector Disablement confirmation window.

- **Enable:** a tick [✓] indicates if the detector is enable.
- **LED Blinking:** a tick [✓] indicates if the LED detector is enable or disable.
- **Label:** this is for the editable device-label. The system will use the label as the device **identifier**.
- **Address:** in this field you can modify the address of the detector;

Options section:

- **assigned zones:** each fire detector, Input module and Manual call Point can be associated with 1 of the available software zones (64 for FC510, 128 for FC520 control panel). If a device goes into ALARM status, all the zones it is connected to (assigned zones) will also go into ALARM status.
- **Base** In this section it is possible to select the base for the detector (click on available bases).
- **Processing section:**
Processing: this determines the actions the control panel will perform when the device threshold is exceeded.

Drift Compensation: Drift compensation effects analogue smoke sensors only. It will supply a precise analysis about dust accumulation, and therefore, the alarm threshold will be modified accordingly.

Use zone setting: the detector uses the parameters of the assigned zone; if this options is disabled, the processing type will be selected.

Prealarm - the control panel will activate the ALARM delay;

Warning - the control panel will activate a WARNING signal.

Operating mode Heat detector:

Day mode-Night mode for Temperature detector (see table 6).

Operating mode Smoke detector: Day mode-Night mode for Smoke and Heath detectors:

- **Default:** for smoke detectors only (813P) and for Smoke and Heath detectors only (801PH)
- **Enhanced:** (for Smoke and Heath detectors only)
- **Sensitivity:** Sensitivity can set:
Low, Medium and High.

☞ *Click-on yellow bar to open or close the relative section of parameters programming*

☞ *If a detector linked to an Output or Input-Output Module, will be disabled (remove a tick [✓] in the proper section), a window will shown to ask confirmation. Click on Detail to see further data (Figure 27).*

☞ *Only for the sirens of the series FC410LPA / S and their base FC430LPA / S the window "Advanced" opens in which you program, tone, volume and frequency of the flashing*

Input modules programming

Click-on an entered Input Modules, the relative programming window will shown as per the following description.

Input module section: as per the same Detectors section;

Assigned zones: as per the same Detectors section;

Operating mode section: select the operating mode style: B, C.

There are 2 operating mode style: B, C;

- **B style:** two wire connection mode: the short-circuit condition as an Alarm condition.
- **C style:** two wire connection mode: the short-circuit condition as a Fault condition.

☞ *As different styles are selected, the electrical operating diagram changes*

Output modules programming

Click-on an entered Output Modules, the relative programming window will shown as per the following description.

Output module section: as per the same Detectors section;

Assigned zones: each Output module can be associated with up to 4 of the 64 available software zones for FC510 control panel, (128 for FC520). An Output module will activated when the zones where is enabled will go into ALARM status.

Base In this section it is possible to select the base for the Output module, click on available bases (for FC430SAM and FC430SAB only).

Beacon It is possible activate the blinking or glowing (ON)

Assigned points: each Output module can be associated with 3 Input Points. If any one of its Input Points goes into ALARM status, the Output module will activate. For each Point it is necessary to indicate:

- the loop the device is connected to (1 or 2);
- the device address.

Options section: this option will allow you to select the conditions that will activate the output module:

- Zone warning, Zone fault, Zone Prealarm, Zone Alarm, Zone Double Knock;
- Point warning, Point fault, Point Prealarm, Point Alarm,
- Panel warning, Panel fault, Panel prealarm, Panel alarm,
- Network warning, Network fault, Network prealarm, Network alarm,

moreover it is possible to program the Output Module as: **Silenceable, Pass trough and Walk test.**

Linked Delay see the same option in the paragraph "Output Programming".

Multiple Input-Output Module - Programming Parameters (FC410MIO)

Click-on an entered **Multiple Input/Output Module FC410MIO** (3 Input Modules and 4 Outputs Modules,

see the customized Manual), the relative programming window will shown.

 Click-on yellow bar to open or close the relative section of parameters programming

The description is as per the same Input/Output Modules section. Compared to this paragraphs, there is a further field "Label" where a description of Input/Output Module will be inserted.

Manual Call Point programming parameters

Click-on a **Manual Call Point** (FC420CP) the relative programming will shown as per the following description.

Manual call point section: come per i Sensori

assigned zones: each Manual Call Point can be associated with 1 of the available software zones (64 for FC510, 128 for FC520 control panel).

➤ **Led blinking:** if this option is enabled, the Manual Call Point LED will blink every Loop scanning.

Zones programming

The **Zone** option from the pull-down menu will allow you to access the software-zone parameters (see Figure 28).

The software zones parameters will be applied automatically to all the devices associated with the zone concerned.

First section (see Figure 28) on the right;

- **Enable:** a tick indicates if the zone is enable.
- **Label:** this is for the editable device-label (up to 20 characters). The system will use the label as the zone **identifier**.
- **Prealarm Duration:** an input device programmed with Prealarm time will generate ALARM status when the prealarm time elapses. (see parameters programming detector).
Select the Prealarm time;
the default prealarm time is 1 minute.
Enter values of 0.00 through 10.00 minutes with steps of 5 seconds.

Options section: many parameters can be programmed in this section.

- **Walk test:** if this option is enabled, the zones in alarm status will activate the programmed Outputs with Walk test, while the control panel will not generate an alarm.
- **Detector Warning:** if this option is enabled the control panel will activate a WARNING signal. N.B. To activate the Warning option for a Module, tick the corresponding box on the Module programming screen.
- **Prealarm:** if this option is enabled, the control panel will activate the ALARM delay.
- **Drift Compensation:** see the same option in "Parameters detectors Programming";
- **Double Knock:** if this option is enabled and the zone is in Prealarm status, when an other devices (other address) associated to this zone will be activated, the zone will immediately generate an Alarm status.
- **Smoke delay:** for each zone, you can program the delayed activation of the smoke detectors.

The procedure can be triggered via software or panel (see page 47)

 Click on Zone number to see which devices are enabled on that zone. Moreover a double click on associated device to zone, opens a Details Device window.

PSTN interface The PSTN interface section is activated, after the FC500PSTN Telecom module has been enabled on the **General Options** screen (**Figure 30**). In this section, each zone may be associated with one or more voice messages linked to an Alarm, Pre-alarm, Start-up, Breakdown or Walk Test event; these may be sent to a maximum of 32 telephone numbers (please refer to the specific FC500PSTN manual).

IP interface The **IP interface** section is active after the module FC500IP has been enabled in the **General Options** page (Figure 30). Each zone can be associated with an event of alarm, Prealarm, Warning, Fault and Test (see the dedicated manual of FC500IP module).

 If the procedure to "restore the factory defaults" of control panel will be executed (see Icon description), even the FC500PSTN Interface is restored to the factory defaults, while the programming data of FC500IP are not affected.

Outputs Programming

The **Outputs** option from the pull-down menu will allow you to access the outputs parameters. The relative programming will shown as per the following description (see Figure 29).

NAC1, NAC2 and NAC3 Outputs

Supervised/Silenceable/Bypassable (Disabled) Alarm Outputs.

Output ACTIVE: positive pull-up to 27.6 V on the [+] terminal; negative pull-down to 0 V on the [-] terminal.

Click-on a Output, the relative programming window will shown:

In the **first sezione**:

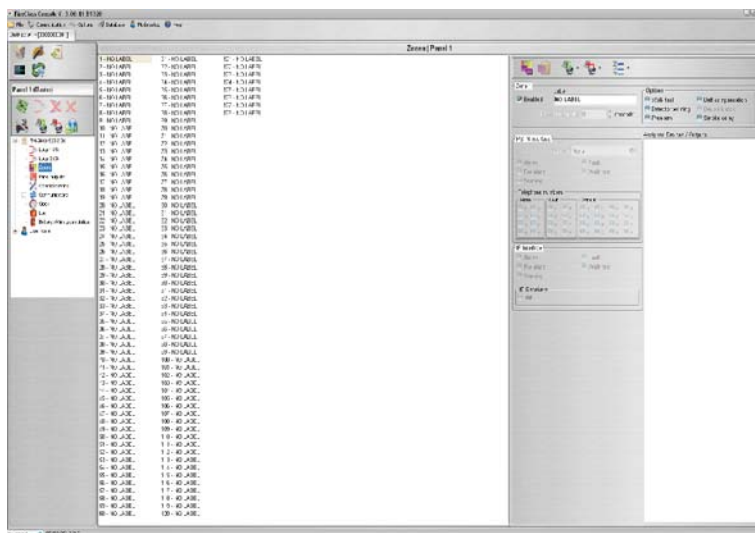

Figure 28 Zones Programming window.

- **Enable:** a tick [✓] indicates if the zone is enable.
- **Label:** this is for the editable Output-label. The system will use the label as the Output identifier.

Program as NAC FIRE If this option is ticked, the NAC1 output is transformed into a NACFIRE output (it is activated in the event of an alarm and cannot be programmed). It is a C-type output (EN 54-1).

☞ When **Program as NACFIRE** has been ticked, the NACFIRE output indicator light **blinks** if the NACFIRE output and/or NAC1 output breaks down; it remains **Glowing** if the NACFIRE output and/or NAC1 output is disabled.

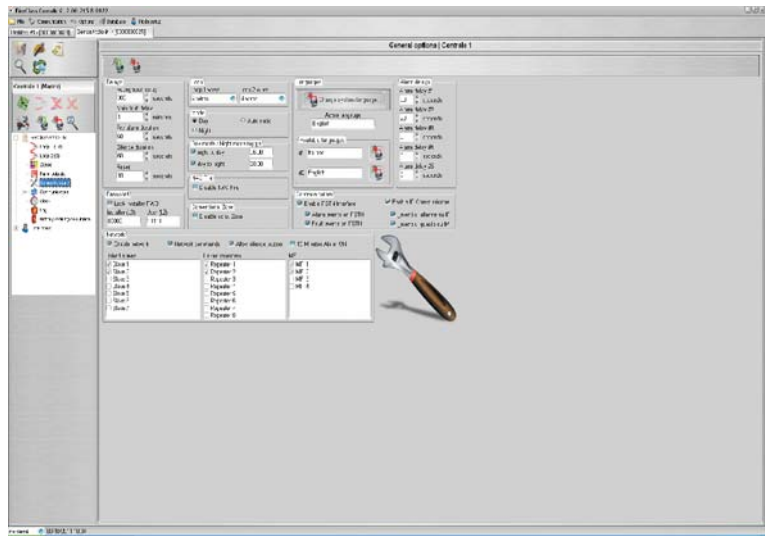

Figure 30 General Options programming window.

Assigned zones: : each Output can be associated with up to 4 of the available software zones (64 for FC510 128 for FC520 control panel).

Assigned points: each Output can be associated with 3 Input Points. If any one of its Input Points goes into ALARM status, the Output will activate. For each Point it is necessary to indicate:

- the loop the output is connected to (1 or 2);
- the address.

Options Section: this options will allow you to select the conditions that will activate the outputs; example: if "Zone warning" option is enabled, the control panel will activate the output when one of its associated points goes into Warning status.

- Zone Warning, Fault Zone, Prealarm Zone, Alarm Zone, Double knock (see Zones programming), Pass trough, zone Walk Test ;
- Point Warning, Point Fault, Point Prealarm, Point Alarm, Network warning, Network fault;
- Panel Warning, Network Warning, Panel Fault, Network fault, Panel Prealarm, Network prealarm, Panel Alarm, Network alarm, Backup PSTN line (see FC500PS manual).

■ OS1....OS8 Outputs

Positive outputs - Programmable - SUPERVISED — Terminals for supervised devices activated by positive (24 V):

Output active — positive (27.6 V) on terminal [OS]; ground on terminal [M].

See the parameters descriptions as per Uscite NAC1, NAC2, NAC3 Outputs.

■ O9....O16 Outputs

These are programmed, NON-SUPERVISED, non-silenceable, bypassable (Disabled) outputs. These are normally-open terminals (open-collector) which close to ground when the corresponding zones go into alarm status. These terminals will remain closed to ground even after the generating event has ended.

See the parameters descriptions as per NAC1, NAC2, NAC3 Outputs.

Linked Delay One of the 5 available timers (set using the General Options screen) may be associated with an output activated by a zone, point or control unit alarm. The output will be activated to coincide with the programmed event, after the delay indicated by the Timer.

General Options programming

The Panel parameters can be programmed through the **General Options** from the pull-down menu (see Figure 30).

Delays section In this section it is possible to program:

- **Recognition delay:** a **Delay** will be added automatically to the Prealarm remaining delay, when the **Investigate Key** will be pressed.

☞ The sum of **Recognition delay** and **Prealarm Time** must not exceed 10 minutes

Main Fault delay: in this field it is possible to program the delay of signalling of Mains failure.

The green signalling LED (Main OK) will be OFF, the Amber signalling LED (Main Fault) will be ON, the relative event will be shown on the display.

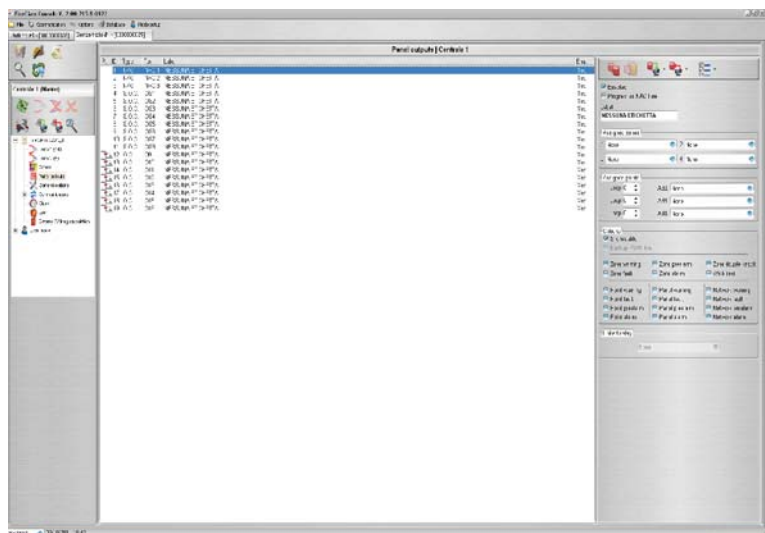

Figure 29 Outputs programming window.

Prealarm duration: an input device programmed with Prealarm time will generate ALARM status when the prealarm time elapses.

Prealarm status is signalled by: an audible signal emitted by the control panel;

- blinking on the PREALARM LED;
- the message on the display;
- activation of outputs with programmed Prealarms.

Silence duration: when the control panel is in **Night Mode** the Silence delay is the maximum silence time of the Outputs.

Reset: program the Reset time (min Time: 2 sec; max Time: reset AUX-RES Output, see AUX-RES terminal).

Password section: the **Password** section will allow you to change the **Installer** and **User** codes. Codes with 1 to 5 digits (0 through 9).

Installer code allows to manage the 3 access Levels of control panel: L1(View), L2 (User), L3 (Installer).

The **default installer** code is **00000**: every digit will be hidden by *(star) symbol.

User code allows to manage 2 access Levels of control panel: L1(View) and L2 (User).

The **default User** code is **11111**: every digit will be hidden by *(star) symbol.

Loop section: in this section select the required Loop configuration: a 2 wire connection or a 4 wire connection.

Language section: select the available language the display of Control panel and Repeater will use. It is possible to upload others languages from the software.

Day-Night mode section: select the DAY or NIGHT mode, or a tick [✓] on **Automatic** enter the time (hour and minutes) when the day-night mode changes.

☞ *When you set the time to transition from DAY to NIGHT mode make sure that the time is less than the hour to be set for switching between Day and Night mode.*

FC500REP: a tick [✓] enables the Repeater faults signalling.

Network: a tick [✓] on **Enable Network** enables the Slave control panel on the Network, and a tick [✓] on **Network Commands** enables the Control panels that have the same tick [✓] to do the commands (Reset, Silence, Investigate) programmed in other Network control panels.

Allow silence buzzer: If this option is enabled it is possible to silence a device that is activated by every part of the network.

In the section **Network** (Figure 30): the options **Linked slaves**, **Linked repeaters** and **MFI** allow you to enable Slave control panels, Repeaters and FC500 MFI modules. For FC500MFI module see the programming from the panel at pag. 50.

NAC Fire: a tick [✓] indicates if the NAC FIRE is disabled.

Conventional zone: a tick [✓] indicates if Conventional zone is disabled.

☞ *The Slave control panel address can be inserted from the User interface of the same control panel; the Repeater address can be inserted from the panel of the same Repeater (see Programming from the panel).*

The FC500PSTN interface and the FC500IP module are enabled in the **Communicators** section. A single click means the interface will be present but not active, while a double-click enables the FC500PSTN or FC500IP module. You may also choose whether to enable both alarm and breakdown events or just one of the two. The delay times corresponding to the zone, point and control panel alarms are set in the **Alarm Timers** section.

Languages: in the **Languages** section, you have the option to change the system language from those available. Once in the **Available Languages** have loaded the two languages among those available, press the

button  to overwrite one of the two languages in the panel memory. As soon as the download of the new language will be completed, the plant will start to use it, and update their device, if necessary. To change the language currently active on the system, use the button

 in the section **Change system Language**.

Advanced In the **Advanced** section you have the possibility to set the thresholds for gas detection device FC410DDM, press the icon .

PSTN interface

For an explanation of the various commands and programming procedures, please refer to the dedicated FC500PSTN manual.

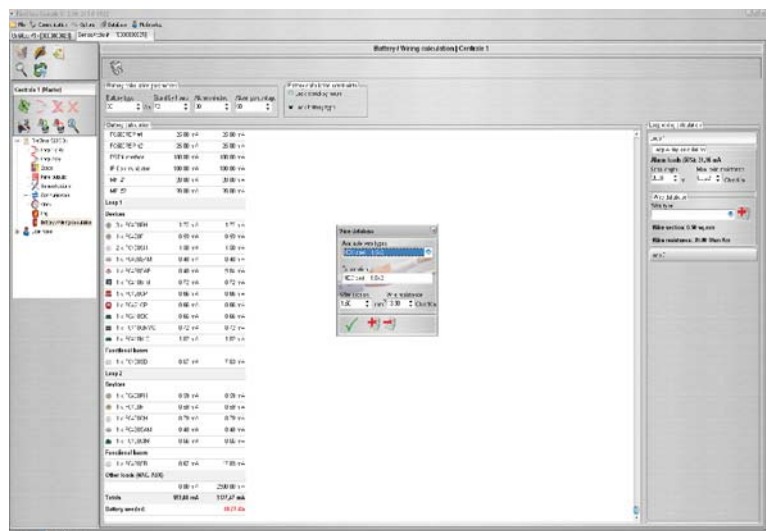

Figure 31 Battery calculation window

IP interface

For an explanation of the various commands and programming procedures, please refer to the dedicated FC500IP interface manual.

CLOCK

The **Date/Time** option from the **CLOCK** menu is for the control panel clock settings.

Enter the required Time and Date.

In case schedule the automatic application of summer time if required.

LOG

This option allows to read the **Log** stores events.

When a Customer will be closed, the system save automatically the present LOG. In this way the LOG is always updated. Description of the icons in the LOG bar:



Up load from Board: click-on this icon to upload the LOG of the connected control panel.



Export LOG to file: click-on this icon to export the LOG in a .fcl file.



Import LOG from file: click-on this icon to import the LOG from a .fcl file.



Apply filter: click-on this icon to select the LOG filter (if necessary):

- No filter
- Restore
- Alarm
- Prealarm
- Warning
- Fault
- Generic
- Walk test



Print a text file; in this case the control panel Event Log, or part of it.



Filter: click-on this icon to select others LOG filter (if necessary):

- Filter by panel
- Filter by Loop
- Filter by device
- Filter by zone.

The following data will be stored in the LOG: the Event's Number, the Date, the Time, the Class (Fault, Alarm, Warning, Generic and Walk test), the Event's description, the Control panel number, the Loop, the Device type, the Status, the Threshold and the Zone.



Clicking on the icon will delete the Event Log, or part of it.

Battery Calculation

The Battery calculation window allows you to see (Figure 31):

- the FireClass500 Loads
- the Loop1, Loop 2 devices loads

in the condition of **Normal Load** and **Alarm Loads** (percentage of devices in alarm status), when the Mains faults.

Below this window, in the option "Others Load", if needed, the Loads on Auxiliary terminals will be inserted.

Automatically the **Total Load** and the **Battery needed** will be shown.

Fixed the **Stand-by hours**, **Alarm minutes** and **Alarm percentage** values the calculation will be done.

Battery calculation Parameters:

- Stand-by hours (From 1 to 144 h)
- Alarm minutes (From 1 to 240 h)
- Alarm percentage

Battery Type: this is the battery (Ah) arising from calculation.

Battery calculation constraints:

- Lock stand-by hours
- Lock battery type.

Lock stand-by hours: "Battery Type" value (Ah) will be calculate, fixed **Stand-by hours**, **Alarm minutes** and **Alarm percentage** ;

Lock battery type: "Stand-by hours" value will be calculate, fixed **Battery Type** (Ah), **Alarm minutes** and **Alarm percentage**.

 *The software calculation is a rough calculation and cannot substitute the Installer and/or Qualified person calculation.*

Loop Wiring calculation

In the same Battery Calculation window (see Figure 31), on the right, FireClass500 Console allows you the **Loop Wiring Calculation**.

After the Loop devices have been programmed, clicking on Loop1 or Loop 2 field (Installation Loop), the **Loop Wiring Calculation** window will open. Insert the wire type in the **Max wire Resistance** field (value in Ohm/Km); automatically, the max Loop length will be shown in the **Loop Length** field (value in m.) .

Vice versa, inserted the **Loop Length**, automatically, the **Max wire Resistance** (Wire type) will be shown.



Clicking on this Icon the **Wire database** will be open. In this database it is possible to insert many type of wires and so these type of wires will be used in the Loop wire calculation.

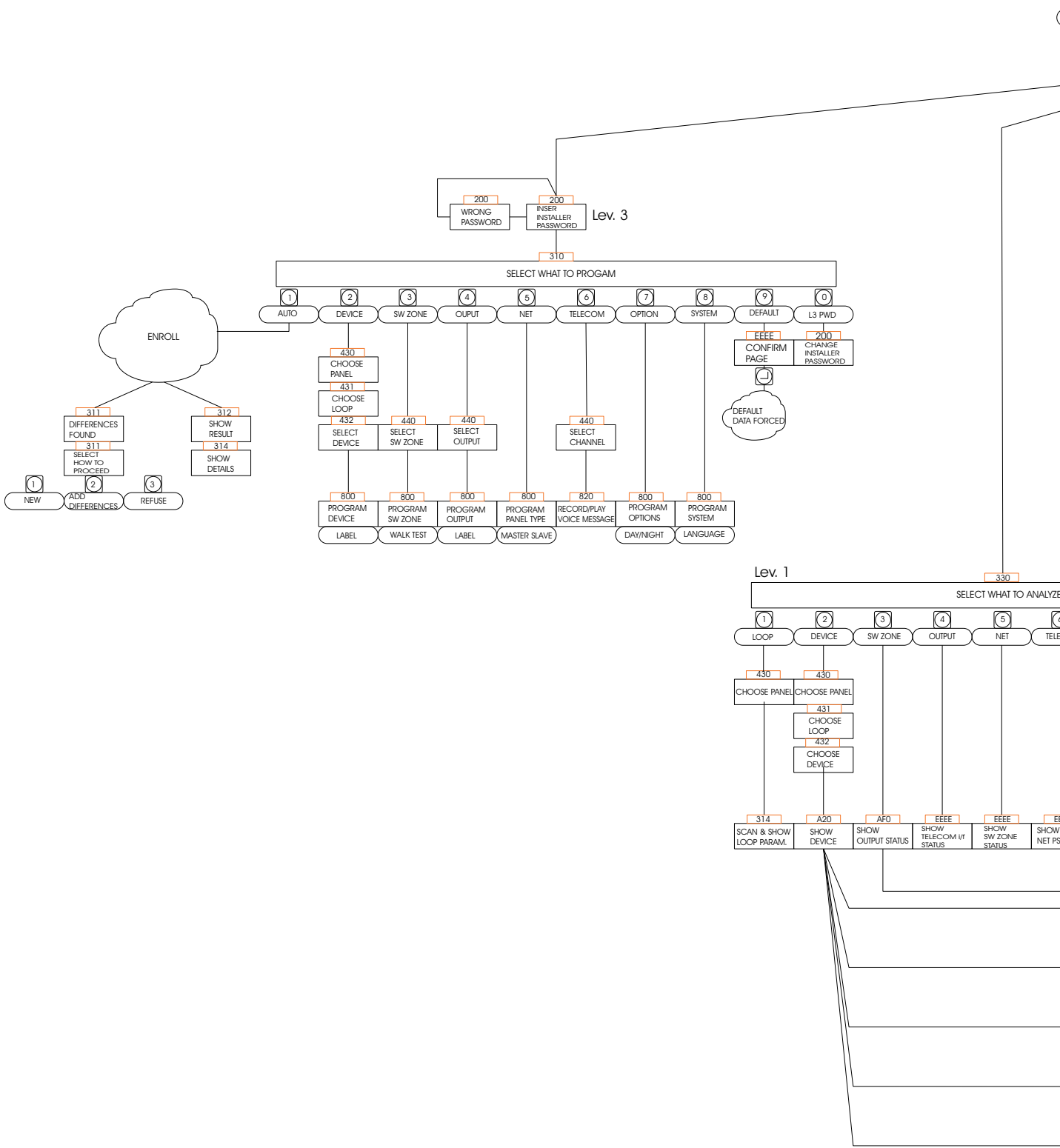
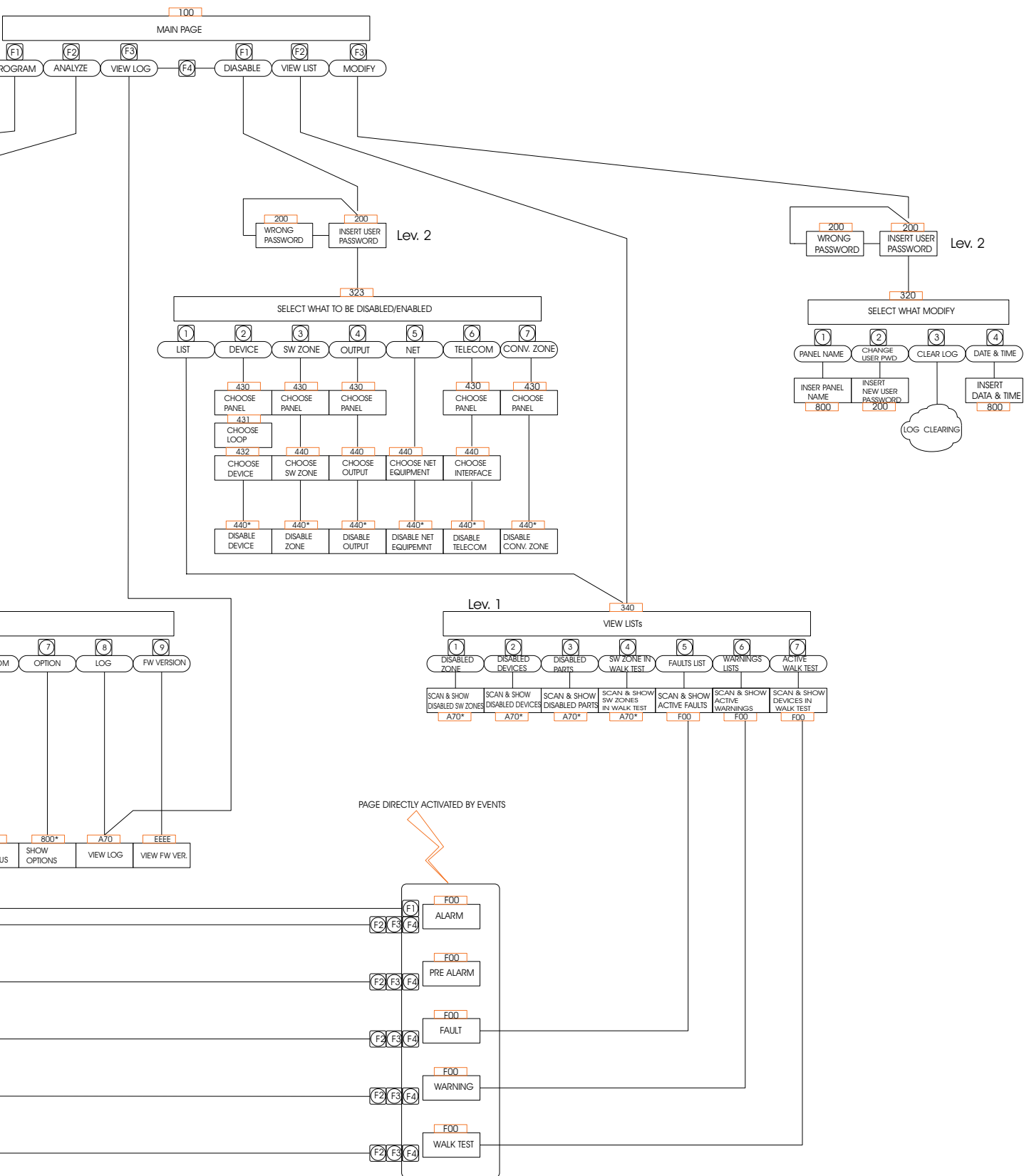



Figure 32 Diagram of all possible operations from the panel, L1, L2 and L3 Levels



 The wire database data is stored in the file "Wire-sList.fcw" inside the FireClass 500 Console Language folder. The database can be moved from one system to another. The Console searches for the wire database while starting, so, if the user cannot access a moved database, simply close the software, and start it again.

 Print a text file; in this case the calculation used to determine the loop charge and establish the type of battery required.

User mode

User mode provides an introduction to the use of Graphical maps. For an explanation of how it works and how to use it, select the Help command from the menu or from the Graphical Maps themselves.

PROGRAMMING FROM THE PANEL

Read through the following section carefully, in order to get an overall view of how to use the User interface Programming (Main panel) of control panel.

For details regarding the parameters of each phase, refer to the respective paragraph in the "PROGRAMMING FROM A PC" chapter.

Using the system

The FC500 system can be managed from the User interface (main panel) and/or through the FireClass500 Console application (the computer must be connected locally via RS232 serial port). The User interface (main panel) allows access to different Level authorized.

There are three different access levels, as follows.

■ L1= First Level: this level allows the Reading Parameters ONLY:

- **F2-ANALYZE** button (see Figure 36) **views** the status of the: LOOP, DEVICE, SW ZONES, OUTPUT, NETWORK, TELECOM, OPTIONS, LOG and the FW Vers.;

- **F3-View LOG;**

- **F2-Wiew. Lists** button **views** the lists of: DIS. ZONES, DIS. DEVICES, DIS. PARTS, WALK TEST, FAULTS, WARNINGS and Dev. in TEST.

■ L2= Second Level or USER Level: access to this level requires entry of the USER PIN (Access Level 2).

This level allows all the operations of the First Level, moreover allows to **MODIFY**:

F3-MODIFY button for: Init MSG (MESSAGE), L2 USER PASSWORD, DAY/NIGHT, TIME and DATE and Clear LOG;







 *To make sure the DAY/NIGHT mode has been updated correctly, check whether the DAY mode LED is switched ON or OFF.*

F1-DISABLE button for: Dis lists, Device, SW ZONES, OUTPUT, NETWORK, Telecom and Conv. ZONE .

■ L3= Third Level or INSTALLER Level: access to this level requires entry of the INSTALLER PIN (Access Level 3).



This level allows all the operations of the First and Second Level, moreover allows to program the security system; the **Programming** phase allows the installer to program the control panel and peripheral devices (detectors, modules, repeater and slave panels), in details: AUTO, DEVICES, SW ZONES, OUTPUTS, NETWORK, TRANSM., OPTIONS, SYSTEM, DEFAULT and PWD L3



■ Operating the system

To manage the system from the User interface (Main panel) is used the Alphanumeric keypad, the Cursor keys, the ESC Key , the ENTER key  and the Functions Keys F1 , F2 , F3  and F4 .



 *In detail the use of Alphanumeric keypad, the Cursor keys, the ESC Key , the ENTER key and the Functions Keys F1, F2, F3 and F4 is shown in every page of PROGRAMMING/DISABLE/MODIFY/READING PARAMETERS.*

Editing a text Use the Alphanumeric keypad to create labels and enter data and codes.

Use **LEFT**  and **RIGHT**  keys to scroll along the line, then press the alphanumeric key to insert in the selected position.

Use the **UP**  key for upper-case letters and the **DOWN**  key for lower-case letters.

Use the **RIGHT** key to enter a space in the text.

Once the text has been completed, press the **ENTER**  key to confirm and step forward, or position the cursor on the first letter of the text then press the  key to step back.

 *In the following pages are shown all possible operations managed at **Level 3 (Installer Level)**. The operation managed at **Level L1 and L2 (User Level)** are shown in the User Manual.*

Main Page - Accessing the system

After this Control panel has been installed and powered from the Mains (230V/50 Hz), the main page of the display shows as per Figure 33.

In this phase:

Alphanumeric keypad No function is related to Alphanumeric keypad.

Cursor keys The **UP** Key: increase the brightness of LCD display;
the **Down** Key: decrease the brightness of LCD display;
the **Right** Key: increase the contrast of LCD display;
the **Left** Key: decrease the contrast of LCD display;

ESC Key No function is related to ESC key.

ENTER Key No function is related to ENTER key.

Function Keys Use **F1** Key to select the **Programming** or **Disable** phase;

Use **F2** Key to show the List Disabled devices or to select the **Analyze** phase;

Use **F3** Key to select the **Modify** phase or to show the events in the **LOG**;

Use **F4** Key to select the related functions to F1, F2, F3 Keys.

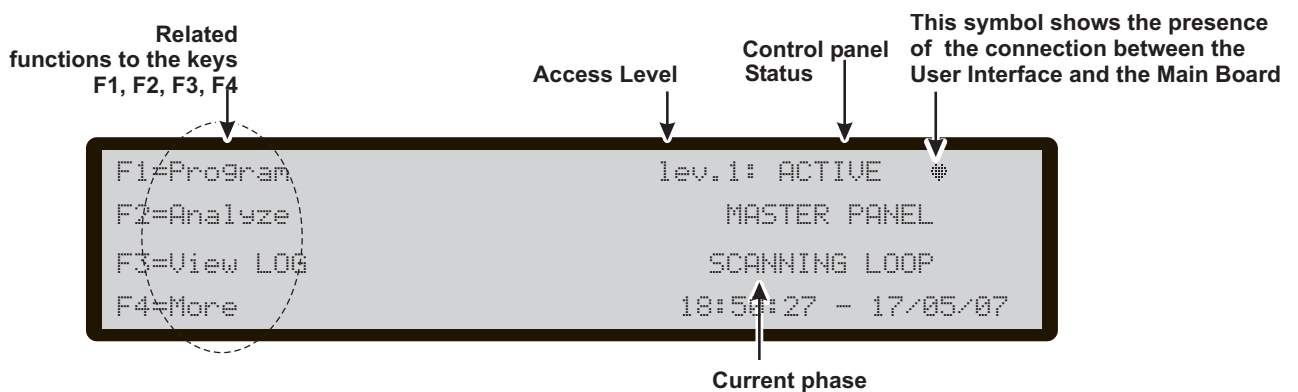

Figure 33 The Main Page of Display

Insert password

After the **F1 Key** is pressed the Figure 34 will shown; in this phase:

the **default** installer code is **00000**: every digit will be hidden by *(star) symbol.

Alphanumeric keypad Use the Alphanumeric keypad to insert the password of **5 digit**.

Cursor keys No function is related to **UP** key.
No function is related to **Down** key;
No function is related to **Right** key;
No function is related to **Left** key.

ESC Key Use the **ESC** key to cancel the input of password and to step back to previous page.

ENTER key Use the **ENTER** key to confirm the password.

Function key No function is related to **F1** key.

No function is related to **F2** key.

Use the **F3** key to cancel the digits of password, if mistaken; insert the new digits;

No function is related to **F 4** key.

If a Password is wrong or missing, the following screen will appear:

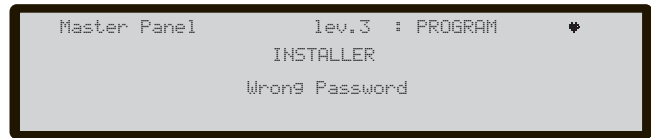

Figure 35 *Display Wrong Password*

to return to the previous screen, press the Esc button or wait for a few seconds

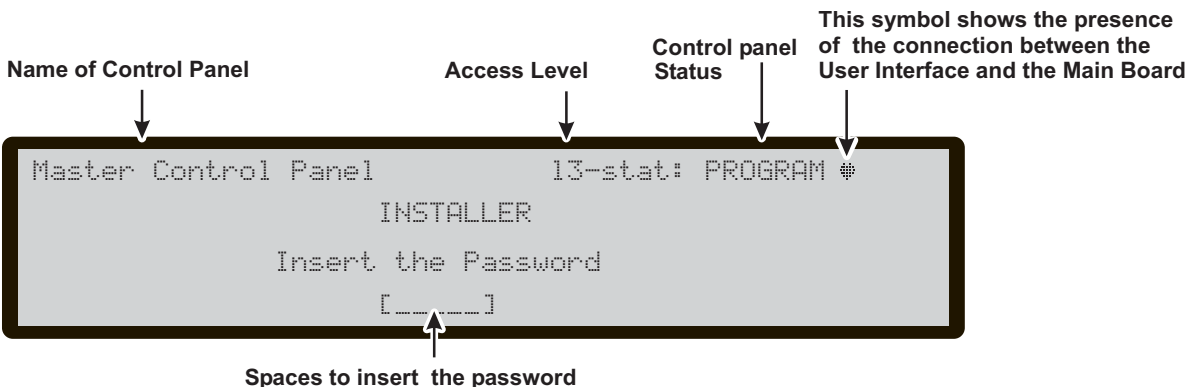

Figure 34 *Insert password (Installer code).*

Programming Page

From Main page, use the **F1** Key to select the Programming phase. Insert the password (installer code) and then the page is shown in Figure 36:

in this phase:

Alphanumeric keypad Use the Alphanumeric keypad to select the different programming functions:

0= L3 PWD; start the page to insert the password of L3 level (Installer code) (see **Insert-Modify password** page);

1= Auto: start the auto-learning of the loop devices and the RS485 network devices automatically;

2= FC Dev: start the selection and programming page of the loop devices;

3= SW Zones: start the programming page of the software zones;

4=Outputs: start the programming page of the Outputs;

5= Network: start the programming page of the RS485 network devices;

6= Telecom: start the programming page of the telecommunication devices;

7=Options: start the programming page of the options;

8=System: start the programming page of the system parameters;

9=Default: forces a default setting restore procedure;

Cursor keys No function is related to **UP** key.

No function is related to **Down** key;

No function is related to **Right** key;

No function is related to **Left** key.

ESC Key Use **ESC** key to cancel the operation and to step back to previous page.

ENTER Key No function is related to **ENTER** key

Function Key No function is related to **F1** key;

No function is related to **F2** key;

No function is related to **F3** key;

No function is related to **F4** key.

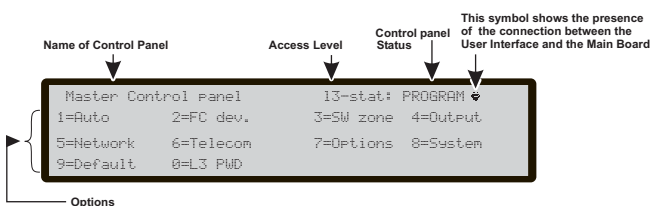

Figure 36 Main programming page

1 KEY- Auto Enrolling (Autolearning)

The **Auto** option from the **PROGRAMMING** menu will allow you to enrol the loop devices and the RS485 network devices automatically.

Autolearning (enrolling) can be done during the installation phase and after changes of the loop and network configurations.

Use the **1 Key** to select **Auto** option, the display will show the Figure 37:

in this phase:

Alphanumeric keypad No function is related to Alphanumeric keypad.

Cursor Keys No function is related to **UP** Key;

No function is related to **Down** Key;

No function is related to **Right** Key;

No function is related to **Left** Key .

ESC Key Use **ESC** key to cancel the operation and to step back to previous page.

ENTER key Use **ENTER** key to view the page of the Loop details.

Function Keys No function is related to **F1** key;

No function is related to **F2** key;

No function is related to **F3** key;

No function is related to **F4** Key.

Warning Enrolling (Autolearning)

When there are some differences between the present configuration and that of the Enrolling (Autolearning) results, the display will show the Figure 37b:

in this phase:

Alphanumeric keypad 1 = delete the old configuration and load the new one;

2 = keep the old configuration, remove the devices no longer present and add the new ones;

3 = keep the old configuration.

Cursor Keys No function is related to **UP** Key;

No function is related to **Down** Key;

No function is related to **Right** Key;

No function is related to **Left** Key.

ESC Key No function is related to **ESC** Key.

ENTER Key No function is related to **ENTER** Key.

Function Key No function is related to **F1** Key;

No function is related to **F2** key;

No function is related to **F3** key;

No function is related to **F4** Key.

In both cases: Auto OK or NOT, the Loop details will be shown (see Figure 37c).

In this phase:

Cursor Keys The **UP** key: shows information relating to the next Loop;

The **Down** Key: shows the information relating to the previous Loop;

No function is related to **Right** Key;

No function is related to **Left** Key .

Attention: when the Enrolling is done, the devices programming data (except their assigned names) will restore to the manufacturers settings (Default) ; therefore a previous configuration will be lost (Choice 1).

0 KEY - insert-Modify password

In this phase (see figure 38):

Installer Code at Default is 00000; every digit will be masked by * symbol.

Alphanumeric keypad Use the Alphanumeric keypad to insert the password of **5 digit**.

Cursor keys No function is related to **UP** key.

No function is related to **Down** key;

No function is related to **Right** key;

No function is related to **Left** key.

ESC Key Use the **ESC** key to cancel the input of password and to step back to previous page.

ENTER key Use the **ENTER** key to confirm the password.

Function key No function is related to **F1** key.

No function is related to **F2** key.

Use the **F3** key to cancel the digits of password, if mistaken; insert the new digits;

No function is related to **F4**.

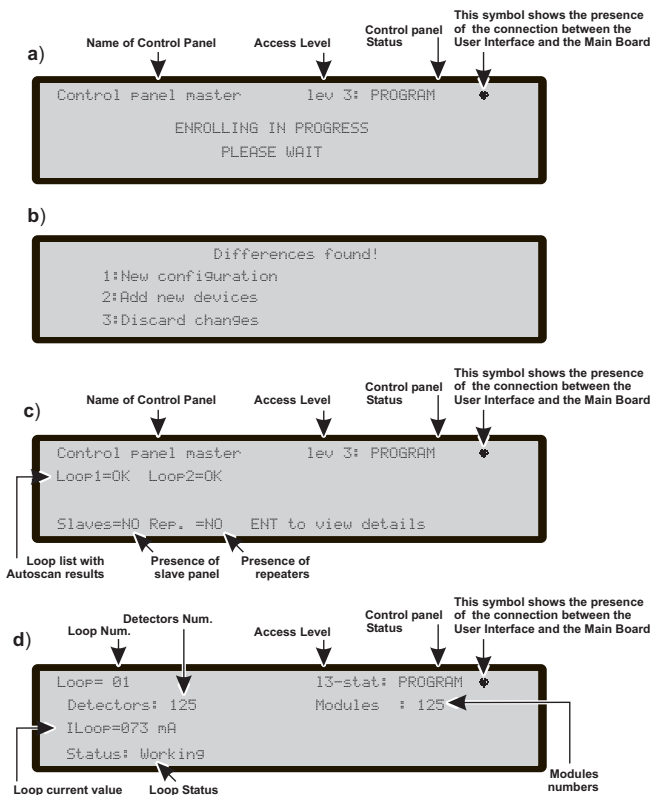

Figure 37 Auto (Enrolling) results pages

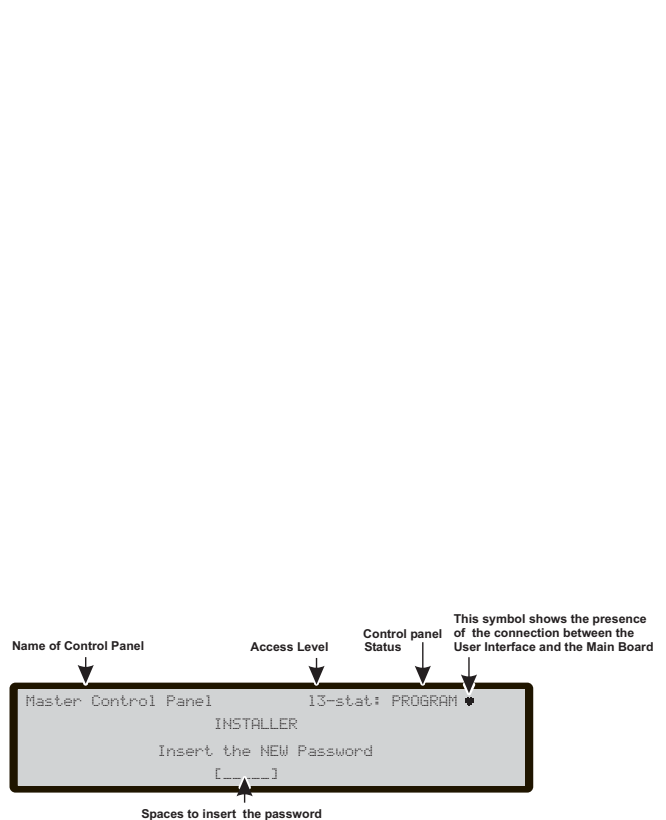

Figure 38 Insert-Modify password (Installer code).

9 KEY- Restore Default

The Restore Default option from the PROGRAMMING menu will allow you to restore default setting.

Use the **9 Key** to select **Restore Default**, the display will show the Figure 39:

in this phase:

Alphanumeric keypad No function is related to Alphanumeric keypad.

Cursor Keys No function is related to **UP Key**;
No function is related to **Down Key**;
No function is related to **Right Key**;
No function is related to **Left Key** .

ESC Key The **ESC Key** deletes the procedure and returns to the previous page;

ENTER key The **ENTER Key** starts the default settings restore procedure.

Function Keys No function is related to **F1 key**;
No function is related to **F2 key**;
No function is related to **F3 key**;
No function is related to **F4 Key**.



Figure 39 Restore default page

KEY 2 -Device

The **Device** command in the PROGRAMMING menu activates the screen used to select and program the devices on the loops;

The Alphanumeric keypad The Alphanumeric keypad is used to digit the address of the device.

Cursor Keys No function is related to **UP Key**;
No function is related to **Down Key**;
The **Right key** selects the next available device;
The **Left key** selects the previous available device

ESC key : ESC key deletes the procedure and returns to the previous page;

ENTER The ENTER key accepts the selection and activates the corresponding programming page.

Function Keys No function is related to **F1 key**;
No function is related to **F2 key**;
The **F3 key** resets the address value entered using the numeric keypad;
No function is related to **F4 Key**.

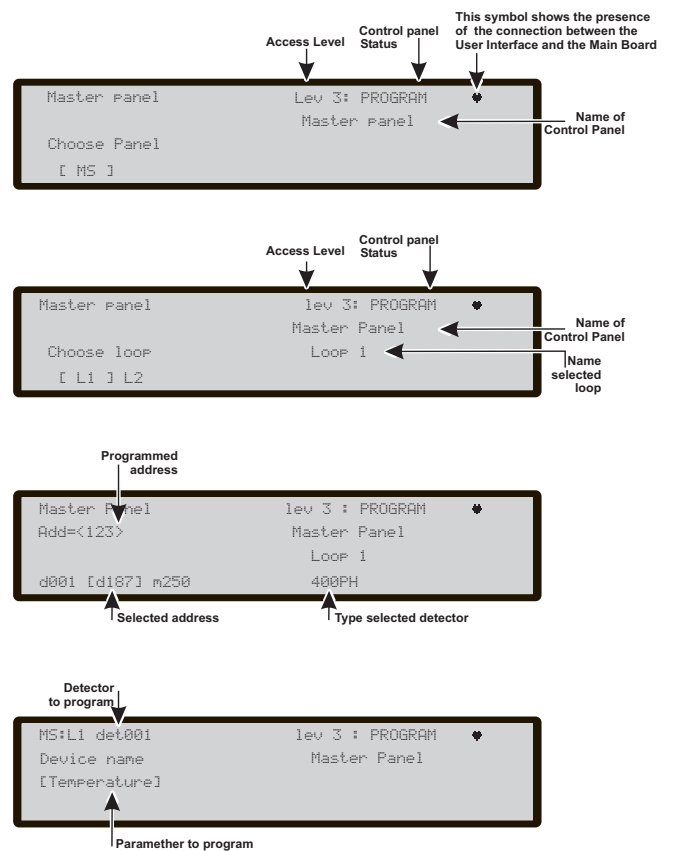

Figure 40 Pages of Selecting and programming Devices on Loop

KEY 3- SW zone

The **SW zone** command in the PROGRAMMING menu activates the screen used to select and program the Software zone on the loops;

The Alphanumeric keypad The Alphanumeric keypad is used to select the number of the zones.

Cursor Keys No function is related to **UP** Key;
No function is related to **Down** Key;
No function is related to **Right** key;
No function is related to **Left** key.

ESC key The **ESC** key deletes the procedure and returns to the previous page;

ENTER The **ENTER** key accepts the selection and activates the corresponding programming page.

Function Keys No function is related to **F1** key;
No function is related to **F2** key;
The **F3** key resets the value entered using the numeric keypad;
No function is related to **F4** Key.

After selecting the SW Zone, you will be able to enable or disable the option Zone in TEST (ON) or not (OFF); in this phase:

Cursor Key No function is related to **UP** Key;
No function is related to **Down** Key;
Right key: selects ON -OFF;
Left key: selects ON-OFF.

ESC Key ESC key deletes the procedure and returns to the programming page.

ENTER key The ENTER key accepts the selection and activates the corresponding programming page

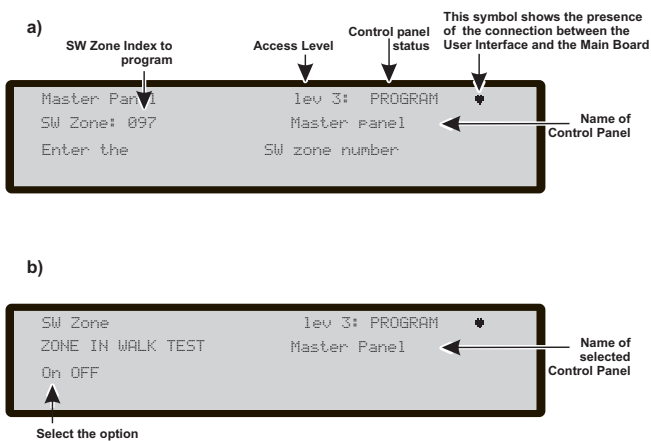

Figure 41 Pages of Selecting and programming of SW zones

Detector alarm verification (Smoke delay)

For each zone, you can program the delayed activation of smoke detectors, according to the following schedule:
 when the smoke level exceeds the threshold of alarm, the panel does not signal anything at first;
 - after 60 seconds if the smoke level is still above the threshold, the system goes into alarm condition, otherwise there are no signals;
 - within 30 minutes, a new level exceeded the threshold of alarm or activation of another sensor in the same zone causes the alarm of control panel.

To program the delay on the activation of smoke detectors, from Programming menu: **SW Zone (KEY 3)**.
 - After selecting the SW Zone, on the following display about the zone to test, select OFF and press Enter.
 - on the following display about the new option "Detector alarm verification", select ON (to enable) and press Enter.
 In this phase:

Cursor Keys No function is related to **Up** key;
No function is related to **Down** key;
Use the **Right** key to select: On-OFF;
Use the **Left** key to select: On-OFF.

ESC key Use **ESC** key to delete the operation and to step back to previous page.

ENTER key Use the ENTER to accept the selection and activate the programming page.

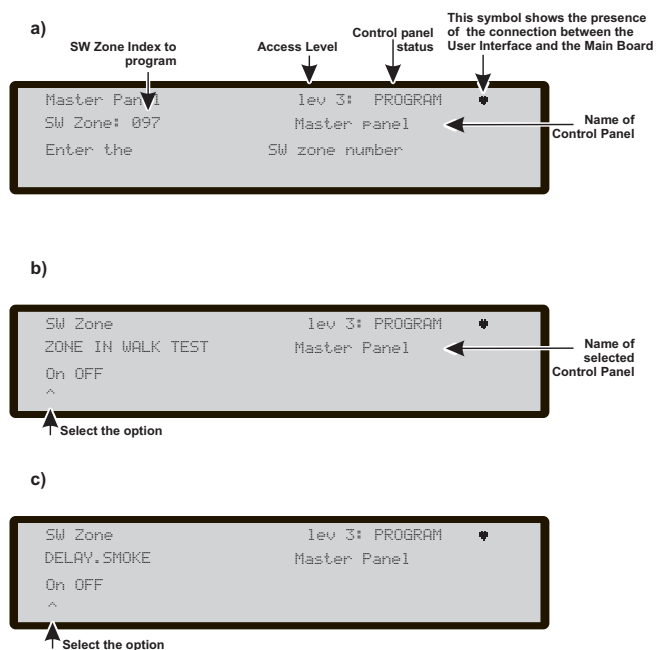

Figure 42 Page of programming option delay Detector alarm verification

4 KEY- OUTPUT

The Outputs command in the PROGRAMMING menu activates the output programming screen. If KEY 4 is used to select **Output** programming, you will be asked to select the output you wish to program; this will be followed by the programming procedure for that output.

■ Choose Output

In this phase:

Alphanumeric keypad The Alphanumeric keypad is used to select the number of the Output.

Cursor Keys The **UP** Key: shows the next/previous output category (**NAC-OC-OS**);

The **Down** Key shows the previous output category;

No function is related to **Right** key.

No function is related to **Left** key.

ESC Key Use **ESC** key to delete the operation and to step back to previous page.

ENTER Key Use the ENTER to accept the selection and activate the view of the next page.

Function Keys No function is related to **F1** key;

No function is related to **F2** key;

Use the **F3** key to reset the value entered using the alphanumeric keypad (if incorrect). Navigate using the Right or Left keys;

No function is related to **F4** Key.

Once the Output has been programmed (type and identification number) and ENTER pressed to accept the selection, enter the label for that output.

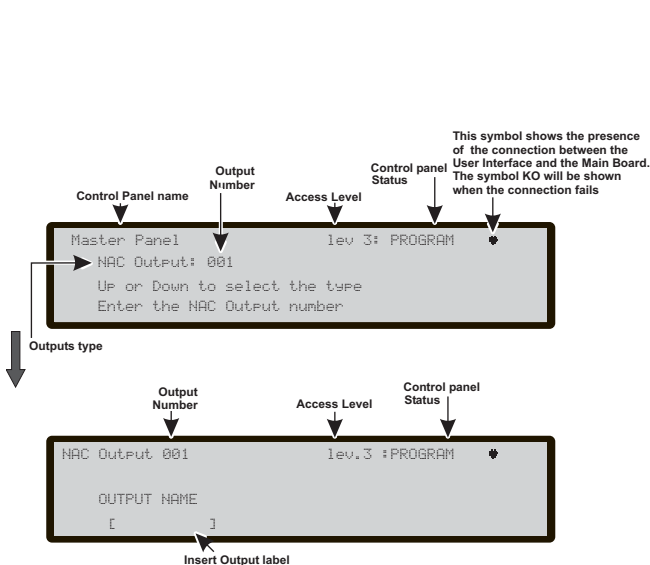

Figure 43 Pages of Selecting and programming Outputs

NAC active on disablements

The programming NAC Outputs can be activated on disablements of any part of the system.

From PROGRAMMING Menu select **Output** (KEY 4) and then work through the following steps:

-insert the number of NAC you want to program the option "NAC active on disablements";

-in the following display insert the name of Output and then press ENTER;

-in the following display, press ON to enable the new option and then press ENTER.

In this phase:

Cursor Keys No function is related to **Up** key;

No function is related to **Down** key;

Use the **Right** key to select: On-OFF;

Use the **Left** key to select: On-OFF.

ESC key Use **ESC** key to delete the operation and to step back to previous page.

ENTER key Use the ENTER to accept the selection and activate the programming page.

If a NAC has this option programmed, it shall be not silenceable.

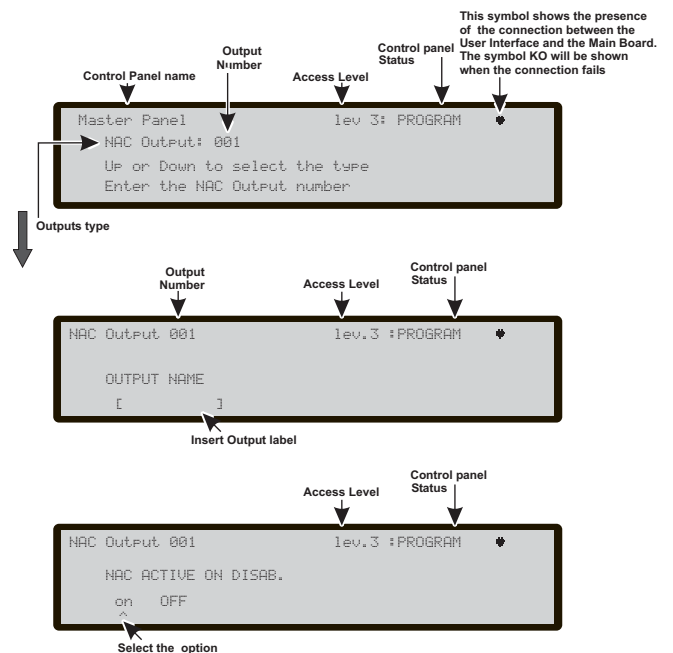



Figure 44 Pages for programming "NAC active on disablements" option.

5 Key- Network

At default, every FC500 Control panel is a Master Control Panel disabled in the Network.

 If a control panel is already configured as "Master", **verify**, via PC, if it is enabled in the Network.
If a control panel is already configured as "Slave", in the new installation, insert the Slave address from the user interface of the Control panel itself.
In the Network **ONLY** one Master control panel must be present.

When all the Control panels and the Repeaters are connected in the Network, the system can be supplied. Now it is necessary to configure the Network, so work through the following steps:

- 1- use the 5 Key to select **Network**, from Programming page (Figure 45) in the User interface of the control panel to be configured;
- 2- the Display of Figure 45 will be shown;
- 3- use the cursor keys to select the type of control panel assigned as "Slave" (address);
- 4- use the Enter key to confirm.

 Every "Slave" control panel inserted in the Network must have a different address.

Alphanumeric keypad No function is related to Alphanumeric keypad;

Cursor Keys No function is related to **UP** Key;
No function is related to **Down** Key;
Use the **Right key** to move on the Right to select the type of the control panel.
Use the **Left key** to move on the Left to select the type of the control panel.

ESC Key Use **ESC** key to cancel the operation and to step back to previous page.

ENTER Key Use the ENTER Key to confirm the address.

Function Keys related to **F1** key;
No function is related to **F2** key;
No function is related to **F3** key;
No function is related to **F4** Key.

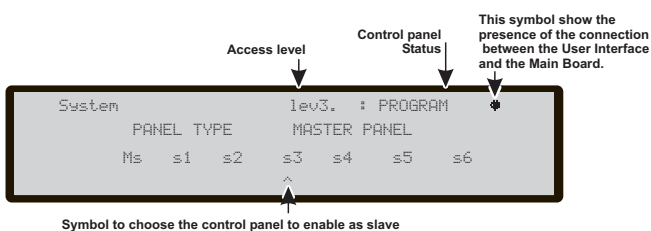



Figure 45 Page to program the address of Slave control panel.

FC500-MFI programming Procedure

To program the module FC500-MFI, do the following from Programming menu (**Network**), press **5** key.

In the programming page "Network" press the ENTER key to confirm the type of panel (FC500MFI),

Select and enable one or more FC500MFI modules (max 4);
select a module by the arrow ⇐ or ⇒ (the symbol ^ under the name show the selected module),
enable a module by the arrow ↑ or disable it by the arrow ↓:
the module name, if enabled, will appear in uppercase (see figure n.46).
Press the Enter key to confirm.

 For an explanation of the features and programming (addresses), see the dedicated manual of the FC500-MFI module.

in this phase:

Alphanumeric keypad No function is related to the Alphanumeric keypad.

Cursor Keys The Up key enable the selected module (es. ON1-uppercase);
The Down key disable the selected module (es. on1-lowercase);
Use the **Right key** to select the module;
Use the **Left key** to select the module;

ESC Key Use **ESC** key to cancel the operation and to step back to previous page.

ENTER key The ENTER key confirm the programming.

Function Keys No function is related to F1, F2, F3 e F4.

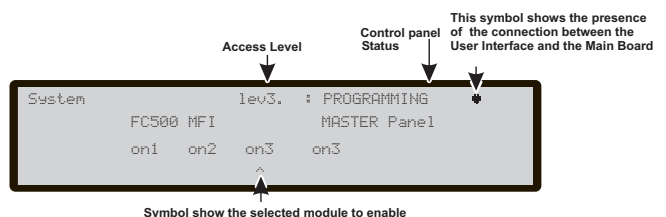

Figure 46 Display to enable the FC500-FMI module

KEY 6-TELECOM

The **Telecom** option in the **PROGRAMMING** menu activates the transmission device programming page. If Key 6 is used to select **Telecom device** programming, you will be taken to the Voice message recording/replaying page, Figure 47: in this phase:

Alphanumeric keypad The Alphanumeric keypad is used to select the number of the Voice message.

Cursor Keys No function is related to **UP** Key; No function is related to **Down** Key; Use the **Right** key to select the next voice message. Use the **Left** key to select the previous voice message.

ESC Key Use **ESC** key to cancel the operation and to step back to previous page.

ENTER Key No function is related to ENTER Key.

Function Keys No function is related to **F1** key; Use the **F2** key to start the record of voice message; Use the **F3** key to start the play of voice message; Use the **F4** Key to stop the record or the play of the voice message.

The transmitter (Telecom module) can record 32 voice messages up to 8 seconds long – See chapter “Appendix: FC500PSTN”

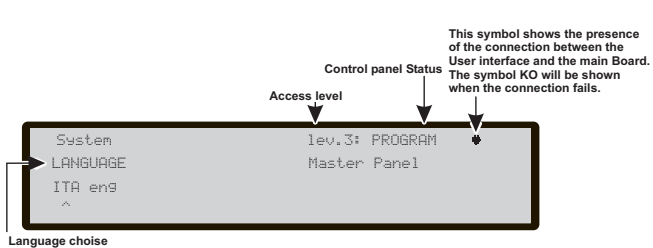

Figure 49 Page to select the language of the system

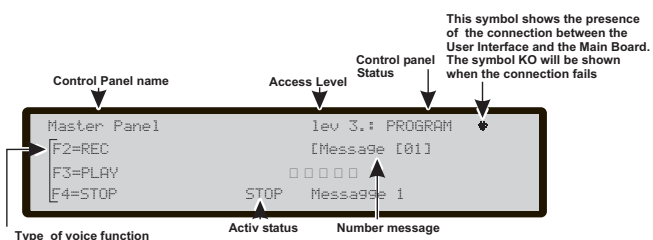

Figure 47 Page to program the PSTN Communicator

KEY 7-OPTIONS

The term **OPTIONS** in the **PROGRAMMING** menu activates the **DAY-NIGHT-AUT** mode programming page. If Key 7 is used to select **Functioning mode**, Figure 48 will show:

For an explanation of Day mode and Night mode operation, please refer to page 6. If you select Automatic, switching between one mode and the other will take place automatically.

in this phase:

Alphanumeric keypad No function is related to the Alphanumeric keypad.

Cursor Keys No function is related to **UP** Key; No function is related to **Down** Key; Use the **Right** key to select the next operating mode. Use the **Left** key to select the previous voice message.

ESC Key Use **ESC** key to cancel the operation and to step back to previous page.

ENTER Key ENTER Key accepts the selection.

Function Keys No function is related to **F1** key; No function is related to **F2** key; No function is related to **F3** key; No function is related to **F4** key.

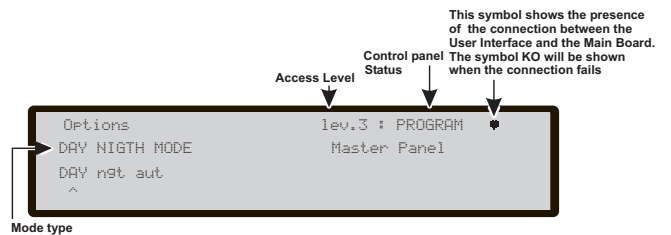

Figure 48 Page to program DAY-NIGHT mode



Figure 50 Display to insert a new FC500REP address

KEY 8-SYSTEM

The option **SYSTEM** in the programming menu activates the system language selection page.

 Other language pairs may be loaded from software

in this phase:

Alphanumeric keypad No function is related to the Alphanumeric keypad.

Cursor Keys No function is related to **UP** Key;
No function is related to **Down** Key;
Use the **Right** key to select the next language.
Use the **Left** key to select the previous language.

ESC Key Use **ESC** key to cancel the operation and to step back to previous page.

ENTER Key **ENTER** Key accepts the selection.

Function Keys No function is related to **F1** key;
No function is related to **F2** key;
No function is related to **F3** key;
No function is related to **F4** key.

FC500REP Repeater Address from the Repeater panel ONLY

After the FC500 control panel has been connected, at the first start-up the FC500REP will verify the presence of the address and its conformity. If the address is correct, the Repeater will start to work; on the contrary the display will ask to insert a new address; the display of Figure 50 will be shown; in this phase:

Alphanumeric keypad Use the alphanumeric keypad to insert the address of 1 digit.

Cursor Keys No function is related to **UP** Key;
No function is related to **Down** Key;
No function is related to **Right** Key;
No function is related to **Left** Key.

ESC Key Use **ESC** key to cancel the operation and to step back to previous page.

Tasto ENTER Use the **ENTER** Key to confirm the address.

Function Keys No function is related to **F1** key;
No function is related to **F2** key;



Figure 51 Display "the repeater link is down"

No function is related to **F3** key;
No function is related to **F4** Key.

 If for any reason the address of a repeater is changed by mistake, the system will show the message of the Figure 51, in this case the address of the repeater will be changed using the **ESC** key.

NETWORK Configuration

Two ways are available to enrol the Network:
first:

1- the Master Control panel can do the Enrolling (autolearning) after one or more Slave Control panels and one or more Repeaters have been enabled in the network (see previous paragraphs);

1a- use the **1** Key to enroll (see page 47);

1b- use the "Upload from board" key (Software FireClass500 console) in the Master control panel;

second:

2- Use the Software (FireClass500 console) to insert one or more Slave Control panels (from Master control panel);

2a- Use the "General Options" section (FireClass500 console) in every Slave control panels to enable the Slave panel in the network;

2b- Use the "General Options" section (FireClass500 console) in the Master control Panel to enable the Slave Control panels, the Repeaters and the Master control panel itself in the network .

2c- Use the " Download to board" key.

After the "Auto" Enrolling the system configure the Network devices (Slave control panels and Repeaters) and besides the Loop devices.

At the end of the "Auto" Enrolling, the "Master" control panel can manage the "Slave" control panels and the Repeaters.

QUICK START-UP PROCEDURE

This procedure allows the quick start-up of the FC510/520 fire detection system.

When the loops are wired, electrically verified and all the devices have been programmed with their related address (using the special FC490ST Loop Service Tool) and installed to the loop, it is possible to connect the loops terminals to the panel.

 *Before powering-on the Fire control panel, ensure that the Earth Line has been connected.*

PROCEDURE

1. Power-on the panel
2. Insert the data and time, if requested (this step is important to guarantee the Log file consistency).

At this point the panel will start the first system initialization verifying the loops integrity, warming up the smoke sensor circuitry, looking for not address programmed devices over the loops and searching devices with the same address.

 *NOTE: The panel in this phase is configured to manage closed loops (4 wires loop), if it is connected to a spur (2 wires loop) will be generate broken loop faults.*

At the end of this first initialization phase will be activated on the user interface the main page with the capability to accede to the command and control functions

3. Select the function Program pressing the key F1
4. Insert the installer password (default=00000) every digit will be masked by * symbol.
5. Choose the option Auto pressing the key 1

The panel will start the enrolling procedure. At the end of this phase will be presented the result of the enrolling in terms of loop with devices connected (OK) or not (KO) and it will be possible view the details for each active loop (number of detectors, number of modules, current drawn), pressing the key [ESC] it is possible to reach again the main page.

 *If the enrolling result differ from the previously stored loop configuration a warning message will be displayed and it is possible to reject the present enrolling result, maintaining the previous configuration, or accept them. Suddenly after the enrolling phase the panel starts the loops initialization phase.*

At the end of this phase, which duration is related to the number and type of the devices connected over the loops, the panel it is able to act according the directive of the EN54-2 standard.

 *The enrolling function will not be activated if there are present loop related faults.*

The functional parameters of the panel and devices at the end of the enrolling procedure are listed below

■ Detectors

FC400H: **A2S** mode

FC400P: **standard** mode, medium sensitivity

FC400PH: (temp. = **A2S**) + (Smoke = **standard** mode, medium sensitivity).

FC400CH: (temp. = **A2S**) + (Carbon Monoxide = **standard** mode, normal sensitivity).

 *All detectors activation will generate panel ALARM*

■ Modules

FC410MIM: input style=**C,NO**

FC410SIO: input style=**C,NO**,
output NOT active

FC410MIO: inputs style=**C,NO**,
outputs NOT active

FC420CP: Call-point fully active

FC430SAB: NOT active

FC430SAM: NOT active

FC421CP: Call-point fully active

FC410CIM: inputs style=**C,NO**

FC410DIM: **standard** mode

FC410BDM: standard mode

FC410RIM NOT active

 *All modules activation will generate panel ALARM*

■ **Zones**

No zone active

■ **Panel outputs**

“**NAC FIRE**” (output EN54-2 type C) active on alarm event

“**FIRE**” (dry contact) active on alarm event

“**FAULT**” (dry contact) active on fault event

■ **Conventional zone**

Active,
pre-alarm on detector activation (680 Ω load),

alarm on call-point activation (270 Ω load),

■ **Panel general option**

Pre-alarm time: 60s

Investigation time: 300s

Silence time: 30s

Mains fault delay: 1min

Day mode

Loop configuration: 4 wires

The following is a list of accessories for control panel in the FC500 series, with a description of the main features. For further information about these accessories, please refer to the instructions supplied with the accessories themselves or download them from the Bentel Security website: <http://www.bentelsecurity.com>

FC500IP - IP Module

The FC500IP is an IP Module which is used to connect control units in the FC500 range to a LAN.

The IP Module may be connected to a LAN using a private IP address or a DHCP address.

The same procedures may be performed using the FireClass500 console application, either through the serial port or the network. With a public IP address, it is also possible to manage and monitor the control unit form anywhere in the world, as long as you have access to the Internet.

FC500PSTN - Telecom Module

FC500PSTN is a Telecom Module which allows implementing the functions of Channel Telephone Dialler and Telemonitoring (functions E and J of standard EN54-1:1996), within the control panels of the FC500 series.

General features:

- Possibility of associating up to 3 voice messages for each event.
- Built-in multiprotocol digital communicator.
- 32 programmable telephone numbers.
- Programming by PC.
- Check for telephone line cutting.
- Excluded line tone check.
- Overvoltage protection.
- Digital message recording playback.
- Built-in speaker for message playback.

5B - Universal Base

The 5B Universal base is for use with the FC400/600 series of detectors.

The base may be fixed directly to:

- British (fixing centres 50mm) or European (fixing centres 70mm) conduit box;
- FC450EMB Euro Mounting Box;
- Directly to the ceiling.

FC400H or FC460H - Addressable Heat Detector

The FC400H heat detector forms part of the FC400 Series of Addressable Fire detectors. The detector is intended to plug into the following:

- 5B 5" Universal Base
- FC450IB 5" Isolator Base
- FC430SB Low Power Sounder Base

Software within the controller is used to interpret the returned heat values to raise an alarm or other appropriate response according to the type of detector configured in Fire Class 500 Console.

The mode of detector may be:

- EN54-5 A1R, rate-of-rise normal ambient
- EN54-5 A2S, fixed 60°C
- EN54-5 CR, rate-of-rise high ambient.

FC400P or FC460P - Addressable Optical Smoke

The FC400P optical smoke detector forms part of the FC400 Series Addressable Fire detectors.

- FC450IB Isolator Base
- 5B 5" Universal Base

Software within the controller is used to interpret the returned optical and heat values to raise alarm or other appropriate response according to the type of detector configured in Fire Class 500 Console.

FC400PH or FC460PH - Addressable Optical Smoke & Heat Detector

The FC400PH optical smoke and heat detector forms part of the FC400 Series of Addressable Fire detectors. The detector is intended to plug into one of the following:

- 5B 5" Universal Base
- FC450IB 5" Isolator Base

Software within the controller is used to interpret the returned optical and heat values to raise alarm or other appropriate response according to the type of detector configured in Fire Class 500 Console. The mode of detector may be:

- Mode 1 - Optical smoke only detector (sensitivity High, Normal or Low)
- Mode 2 - Optical (sensitivity High, Normal or Low) and heat fixed temperature 60°C (A2S)
- Mode 3 - Heat only rate-of-rise (A1R) detector (no sensitivity selection)
- Mode 4 - Heat fixed temperature 60°C (A2S) (no sensitivity selection)

- Mode 5 - Heat rate-of-rise (A1R) detector and optical smoke (sensitivity High, Normal or Low)
- Mode 6 - HPO (Advanced) smoke detector (sensitivity High, Normal or Low)
- Mode 7 - HPO (Advanced) and heat fixed temperature 60 °C (A2S)
- Mode 8 - HPO (Advanced) and heat rate-of-rise (A1R).

 *FC460P, FC460H and FC460PH, these devices shall be managed only in backward compatible mode, i.e. their new feature (auto-addressing) will not be available. In the control panel and in the PC software (FireClass500 console), they will be visualized as the devices they substitute (FC400P, FC400H and FC400PH respectively)*

FC410LI - Line Isolator Module

The FC410LI Line Isolator Module is designed to be used on the FC addressable controller loop circuits. It monitors the line condition and when detecting a short circuit will isolate the affected section whilst allowing the rest of the addressing circuit to function normally.

The purpose of the FC410LI Line Isolator Module is to ensure that, on a looped addressable system, no short circuit fault can disable more detection devices than would be lost on a conventional non-addressable fire circuit.

FC410MIM - Mini Input Module

The FC410MIM Mini Input module is designed to monitor fire contacts, such as extinguishing system control, ventilation control, fire door control etc. The module provides one identifiable detection spur which is capable of monitoring multiple normally open contacts or a single normally closed contact.

The FC410MIM can be mounted in any electrical enclosure with sufficient depth to accommodate FC410MIM and the contacts monitored by the IN+ and IN- terminals, ie, no field wiring. The remote LED (if required, not supplied) must be located within the same electrical enclosure.

FC410MIO - Small Addressable Multi I/O Module

The FC410MIO Multi I/O Module has three class B inputs and two outputs from latching relays. The class B inputs can monitor fire contacts such as extinguishing system control, ventilation control, fire door control etc. The two relays outputs are dry form C that provide volt-free relay changeover contacts.

A maximum of two HVR800 High Voltage Relay Modules can be individually driven and controlled by an FC410MIO if all HVR800s are powered by 24V dc or 24V ac. In this application, the HVR800s are controlled by the two latching relays on the FC410MIO.

A maximum of four HVR800 High Voltage Relay Modules can be individually driven and controlled by an FC410MIO if all HVR800s are powered by 120V ac or 240V ac. In this application, the HVR800s are controlled by the four control outputs (O1+/O1- to O4+/O4-) on the FC410MIO.

FC410SIO - Single Input/Output Module

The FC410SIO Single Input/Output Module is designed to provide a monitored open collector input and a volt free relay changeover output.

FC410SIO can switch up to 2 A @ 24 Vdc.

FC420CP - Addressable Break Glass Callpoint (indoor)

FC420CP Addressable Break Glass Callpoint is designed to monitor and signal the condition of a switch contact that is operated by activating the break glass element. The type of alarm generated by the callpoint is configured in FireClass 500 Console. The FC420CP callpoint meets the requirements of EN54 Pt.11. The FC420CP is fitted to a standard surface mount plastic backbox, standard single gang metal plaster box (35 mm for flush mounting) or standard single gang metal plaster box (25 mm) with backbox.

FC421CP - Addressable Break Glass Callpoint (outdoor)

FC421CP Weatherproof Addressable Break Glass Callpoint is designed to monitor and signal the condition of a switch contact that is operated by activating the break glass element. The type of alarm generated by the callpoint is configured in FireClass 500 Console. The FC421CP callpoint meets the requirements of EN54 Pt.11. The FC421CP is fitted into a standard weatherproof break glass callpoint housing.

FC430SAB/SAM - Sounder Base Address Modules

The Sounder Base Address Modules (FC430SAM/FC430SAB) are designed to control a loop powered sounder base for use with the FC system, one variant (FC430SAB) has an integral beacon. They may also be used to drive a relay base. The units are used to supply the address decoding in place of a detector, thus providing a loop powered sounder when used in conjunction with an FC430SB. The modules are colour matched to the sounder bases. The FC430SAM/FC430SAB is locked into the base using the locking device integral to the sounder base.

FC430SB - Loop Low Power Sounder Base

The FC430SB Loop Low Power Sounder Base provides an additional sounder function on the FC addressable loop circuit. The FC430SB Loop Low Sounder Base requires an associated detector in order to operate, as it uses the address of the detector that is fitted to it. Removal of the detector or loss of power to the loop will cause the sounder to cease operating. A maximum of 45 Sounder Bases at full volume may be connected to the loop.

FC450IB - Isolator Base

The FC400 Series Detectors, as supplied, use a common FC450IB Isolator Base assembly.

The base may be fixed directly to:

- British (fixing centres 50mm) or European (fixing centres 70mm) conduit box;
- FC450EMB Euro Mounting Box;
- Directly to the ceiling.

FC490ST - Loop Service Tool

The FC490ST Loop Service Tool is used to program the loop address into FC addressable devices. The FC490ST displays information and performs tests on devices. It has a 32 character backlit LCD alphanumeric display, arranged in 2 rows of 16 characters and four 'softkeys', F1, F2, F3 and F4. Power for the FC490ST is derived from 4 AA size nickel metal hydride rechargeable batteries. It may be run from an unregulated +12V dc input ie, car cigarette lighter connection or 110/230V ac mains adaptor, both of which will recharge the batteries as well.

FC410BDM - Beam Detector Module

The FC410BDM Beam Detector Interface Module is designed to interface FIRERAY 50 Beam Detectors to the FC Digital Addressable Loop (it must not be used with other types of beam detector). The FC410BDM monitors the Fire and Fault contacts and also monitors for open and short circuits on the connections between the interface and the beam detector. For remote siting of the FIRERAY 50 an optional BTM800 Terminal Module can be used with 4 core cable.

The FIRERAY 50 transmitter and receiver units are mounted in the same housing.

The FC410BDM Loop Powered Beam Detector Interface Module is contained on a double sided printed circuit board (PCB) which is fitted into a custom built fascia plate with a protective cover being fitted over the PCB, leaving only the connection terminals exposed. The fascia plate is then fitted onto a standard dual-gang back box with BESA fittings.

FC410CIM - Contact Input Module

The FC410CIM FC Addressable Contact Input Module is designed to monitor fire contacts such as extinguishing system control, ventilation control, fire door control etc. The FC410CIM can be configured as:

- Two spur circuits (Class B) monitoring multiple normally open contacts, with short circuit giving a fault output.
- Two spur circuits (Class B) monitoring single normally closed contacts, with short circuit giving a fault output.
- Two spur circuits (Class B) monitoring multiple normally open contacts, with short circuit giving an alarm.

FC410DIM - Detector Input Module

The Addressable FC410DIM provides the ability to connect and interface one or two zones of 24V dc 2-wire conventional detectors (non-addressable) to the Fire Alarm Controller.

The FC410DIM monitors the status of detectors and wiring to detectors and signals detector and wiring status back to the Controller.

FC410RIM - Relay Interface Module

The FC410RIM Relay Interface Module provides one volt-free relay changeover contact on a latching relay. The relay is controlled by a command sent from the FC fire controller via the addressable loop. The relay state (activated, deactivated or stuck) is returned to the controller.

FC400CH - Addressable Carbon Monoxide + Heat Detector

The FC400CH carbon monoxide plus heat detector forms part of the FC400 Series Addressable Fire detectors.

The detector is intended to plug into the following:

- 5B 5" Universal Base.
- FC450IB 5" Isolator Base.
- FC430SB Low Power Sounder Base.

The detector is designed to transmit, to a remote Fire Class controller, digital signals which represent status of the carbon monoxide and heat elements of the detector. Software within the controller is used to interpret the returned carbon monoxide and heat values to raise alarm or other appropriate response according to the type of detector configured in Fire Class 500 Console.

801RIL - Remote LED Indicator

The 801RIL Remote Indicator is used where a detector LED is not visible ie, when the detector is mounted in a roof void, lift shaft etc. The 801RIL is mounted to a single gang electrical box and is supplied with 2 x M3.5 screws.

801HL - Remote LED Indicator

The 801HL Remote Indicator is used where a detector LED is not visible ie, when the detector is mounted in a roof void, lift shaft etc.

The 801HL provides a larger indicator for use in place of the 801RIL when longer distances are involved or in VdS influenced markets.

The 801HL can be mounted to any suitable flat surface and has fixing centres at 60 and 80mm.

HVR800-High Voltage Relay

The HVR800 High Voltage Relay Interface is a non-addressable multi-voltage relay module (operating from 24V dc, 24V ac, 120V ac and 240V ac).

The encapsulated HVR800 provides a 10 amp volt-free contact that can be used to extend the contact ratings of FC410RIM Addressable Relay Module applications.

A maximum of four HVR800s can be individually driven

and controlled by an FC410MIO Small Addressable Multi-Input/Output module if all HVR800s are powered by 120V ac or 240V ac.

For ac operation, no external dc power supply unit is required to operate the relay.

When used to switch 24V dc, the HVR800 must be provided with an external 24V dc supply which should be switched through the clean relay contacts of an FC410MIO or FC410RIM.

MP69-Duct Probe Unit

The MP69 Duct Probe unit are designed to be installed in air conditioning supply and exhaust ducts for the purpose of monitoring the airflow for smoke and combustion products.

The Duct Probe Units are designed to accept and will operate satisfactorily with the 600 and FC400 Series detectors. The Duct Probe units are factory fitted with the FireClass Universal Base 5B.

FIRERAY 50-Optical Beam Smoke Detector

The Detector comprises a Transmitter and Receiver contained within one enclosure.

The Transmitter emits an invisible infrared light beam that is reflected via a prism mounted directly opposite and with a clear line of sight. The reflected infrared light is detected by the Receiver and analysed.

The Detector has a maximum lateral detection defined by the local National Standard. As a guide a common lateral distance of 7.5m will be used in this guide. Use the latest beam detector standards EN54 part 12, VdS2095 or BS5839 part 1 for further guidance.

The optimal beam distance from the ceiling will be between 500mm and 600mm, again the Local National Standard will give guidance.

FC410LPSY and FC410LPAV loop powered sounders and sounder-beacons

The FC410LP Series of Loop Powered Addressable Sounder/ Sounder-Beacons are designed to be driven from an FireClass control panel via the addressable loop. The FC410LP Series of sounders/sounder beacons consist:

FC410LPSYR Sounder (indoor use) - red housing

FC410LPSYW Sounder (indoor use) - white housing

FC410LPSY Sounder IP65 (outdoor use) - red housing

FC410LPAVR Sounder-Beacon (indoor use) - red housing

FC410LPAVV Sounder-Beacon (indoor use) - white housing

FC410LPAV Sounder-Beacon IP65 (outdoor use) - red housing

The sounder has two volume settings 'High' (103 dB \pm 3) or 'Low' (90 dB \pm 3).

The beacon has two flash rates 'Slow Flash' (1/2 Hz) or 'Fast Flash' (1 Hz).

The FC410LP devices are synchronised, but not synchronous with other FireClass sounders (FC430SB/FC410SNM) and beacons (FC430SAB).

The first flash of the beacon is synchronised with the

start of the tone.

The FC410LP devices have a built in two port isolator.

FC430LPSB and FC430LPASB Loop Powered Addressable Sounder/Beacon Base

The FC430LP Series of Loop Powered Addressable Sounder/Sounder- Beacons are designed to be driven from an FC500 control panel via the addressable loop.

Tone, volume and flash rates are set in FireClass Console.

The sounder has four volume settings 'High' (90dB \pm 3), 'Mid High' (80 \pm 3dB), 'Mid Low' (70 \pm 3dB) or 'Low' (60dB \pm 3).

The beacon has two flash rates 'Slow Flash' (1/2Hz) or 'Fast Flash' (1Hz). The FC430LP Series have a built-in line isolator.

FC410SNM Sounder Notification Module

The FC410SNM Sounder Notification Module is designed to provide an output, in response to a command signalled from a controller, to activate a number of polarised and suppressed sounders. The sounders are powered from an independent power supply and the module is capable of passing up to a maximum of 2A (eg, 24V dc 50mA company sounders or a mixture of different current rated sounders not exceeding a maximum current of 2A).

 *The possibility of the configuration of extinction, although present in the FC410SNM module, is not available for FC510 and FC520 control panel.*

FC410TSM – door control module

The FC410TSM Door Control Module is designed to close a fire door in case of alarm or fault. The door is normally kept open by electromagnets. The door control module disconnects the electromagnets from power supply in order to allow the door to close. The FC410TSM has a relay changeover output and a monitored input. The FC410TSM contains an integrated line isolator and self-monitoring circuits (monitoring of communication with a panel, loop power monitoring), which enables the fire door to be closed when communication with a panel is lost for longer than 45s (\pm 5s) or the loop power drops below $U_{min}=19V$ for more than 15s (\pm 1.5s). In addition, the FC410TSM monitors the external 24V supply.

FC410DDM – Universal fire and gas detector module

The FC410DDM provides the ability to connect and interface 2 zones of 20 V DC 2-wire conventional fire detectors, or two 4-20 mA signalling sensors, to the FireClass fire alarm controller. The FC410DDM monitors the status of the detectors and the wiring to the detectors and signals detector and wiring status back to the controller. The conventional detector circuits can be configured in one way: To monitor 1 or 2 Class B spur circuits The 4-20 mA signalling sensors may be one of two types:

- Current sinking
- Current sourcing.

FC410QIO Quad input output module

The module provides four monitored digital inputs and four potential free relay changeover outputs.

The outputs are monitored with parallel contacts of the relays. The outputs can be connected to an Auxiliary Voltage source and its voltage can be monitored.

Additionally, all the outputs can be connected to the HVR800, for switching high power galvanic isolated loads. For more details refer to the HVR800 documentation.

The module has an integral loop isolator. If this activates a yellow LED illuminates. The activation remains in place until the short is removed.

The digital input monitoring and isolator functions are both configurable.

Maximum relay current: 2A.
Maximum relay voltage: 30V.

FC410QRM Quad relay module

The module provides four potential free relay changeover outputs. The outputs are monitored, with parallel contacts of the relays. The outputs can be connected to an Auxiliary Voltage source and its voltage can be monitored.

Additionally, all the outputs are configurable to the HVR (High Voltage Relay) mode, which allows you to connect up to four HVR800 modules for switching; for example 240V loads galvanically isolated.

The module has an integral loop isolator. If this activates a yellow LED illuminates. The activation remains in place until the short is removed.

Maximum relay current: 2A.
Maximum relay voltage: 30V.

This quick guide is for installers with knowledge of the control panels, and fire control panels in general. This chapter holds all the necessary installation details.

Technical features

Some of the technical features, regarding the terminals on the Main, are described in the following paragraph.

| Control Panel | FC510 | FC520 |
|--|---|-------|
| Main voltage | 230 V ~ 50 Hz -15/+10% | |
| Aux. Outputs Nominal Voltage | 27,6 V | |
| Aux. Outputs Min. and Max. Voltage | 19,0 ÷ 27,6 V | |
| Minimum output voltage | 19,0 V ± 5 % | |
| Max. current draw | 1,6 A | |
| Power | 35 W | |
| Maximum available current (1) | 4,2 A with 17Ah batteries 3,2 A with 38Ah batteries | |
| Control Panel max. current draw at 27.6V | 0,3 A | |
| Ripple | 1 % | |
| Suitable batteries: make model | 2 * 12 V/17 Ah YUASA NP 17-12 FR or equivalent with case flame class UL94-V2 or higher | |
| Maximum internal resistance of the battery and associated circuitry | 1 Ω | |
| Temperature range | -5 ÷ +40 °C | |
| Dimensions (W*H*D) | 445*578*111 mm | |
| Weight | 9 Kg (without batteries) | |

Table 7 Technical features

The following table shows the technical features of the Repeater FC500REP.

| REPEATER | FC500REP |
|--------------------|---------------|
| Main voltage | 27,6 V |
| Maximum current | 180 mA |
| Temperature range | -5 ÷ +40° |
| Dimensions (W*H*D) | 390x215x50 mm |
| Weight | 2,05 Kg |

Description of the terminals

The terminals of the Main board and Switching power supply, are described briefly in the a Table 8: the standby (normal) status is the first, followed by the alarm status. Moreover, the Voltage present during the different operating conditions is indicated for each terminal, as well as the maximum current (in amps) that can circulate.

In the following table the current values of every functions of control panel.

| Available Current | 5,5A | 5,5A |
|-------------------------------------|-------|-------|
| Battery capacity | 17Ah | 38Ah |
| Battery charge | 1A | 2A |
| NACs Outputs | 2A | 1A |
| Auxiliary Outputs (24AUX, 24RES) | 0,5A | 0,5A |
| LOOPs (2) | 0,8A | 0,8A |
| 12V Output | 0,15A | 0,15A |
| Conventional Zone | 0,06A | 0,06A |

1) For the power supply of the external devices. (see table 8)

2) Connect a 3900 ohm resistor between the [+] and [-] terminals of the NAC1, NAC2 and NAC3 Outputs, if not used (see table 8).

| TERM. | DESCRIPTION | v(V) | i(A) |
|------------------------------|--|-----------|-------------|
| MAIN BOARDS | | | |
| +L1-LEFT | (+)Loop 1-Positive signal, left side. (-)Loop 1-Negative signal (return), left side | — | — |
| +L1-RIGHT | (+)Loop 1-Positive signal, right side. (-)Loop 1-Negative signal (return), right side | — | — |
| +L2-LEFT | (+)Loop 2-Positive signal, left side. (-)Loop 2-Negative signal (return), left side. | — | — |
| +L2-RIGHT | (+)Loop 2-Positive signal, right side. (-)Loop 2-Negative signal (return), right side. | — | — |
| [LC] | CONVENTIONAL LINE: balanced line with 3900 ohm → control panel in standby unbalanced line → Conventional Zone activated line in short-circuit or open → fault on the Conventional Zone | — | — |
| [⚡] | Ground | 0 | — |
| +485- | SERIAL BUS. Terminals to connect the FC500REP and SLAVE control Panel | — | — |
| [⚡] [24V] | 24 V POWER Output for the FC500REP and SLAVE control Panel: Positive pull-up to 27.6 V on [24V] terminal Negative pull-down to 0 V on [⚡] terminal | 27,6 0 | 0,5(1) — |
| [AUX] | 24 V AUXILIARY POWER SUPPLY: negative present on terminal [⚡]; positive present on terminal [24A]. | 0 27,6 | 0,5(1) |
| [AUX-RES] | 24 V AUXILIARY POWER SUPPLY: negative present on terminal [⚡]; positive present on terminal [24A]. | 0 27,6 | 0,5(1) |
| [NC] [NO] [C] FIRE | FIRE ALARM OUTPUT - Non-Supervised: standby → [C] connected to [NC] with [NO] open; in the event of ALARM → [C] connected to [NO] with [NC] open | — | — |
| [NC] [NO] [C] FAULT | FAULT ALARM OUTPUT - Non-Supervised: standby → [C] connected to [NC] with [NO] open in the event of fault → [C] connected to [NO] with [NC] open | — | — |
| +BAT2- | BATTERY CONTROL PANEL POWER SUPPLY | 27,6 | |
| +BAT1- | BATTERY CONTROL PANEL POWER SUPPLY | 27,6 | |
| [OS1]... [OS8] | Programmable Outputs(Open collector)- Silenceable-Bypassable (Disabled)-Supervised (The polarity is not programmable) | 27,6 | |
| [O9]... [O16] | Programmable Outputs(Open collector)- Silenceable-Bypassable (Disabled)-NOT Supervised (The polarity is not programmable) | 0 | 1 |
| -NAC FIRE+ | Type C output (EN54-1) - Silenceable, Bypassable (Disabled), Supervised Terminals for supervised devices activated by positive (24 V): During ALARM status — positive (27.6 V) on terminal [+]; negative on terminal [-]. | 27,6 | |
| [NAC1] [NAC2] [NAC3] | Programmable—Supervised—Silenceable—Bypassable (Disabled) ALARM Outputs: Panel in Standby → negative on [+] terminal; positive 27.6V on [-] terminal Panel in Alarm → positive 27.6V on [+] terminal; negative 0 V on [-] terminal | — | (2) |
| [12V] | 12 V AUXILIARY POWER SUPPLY: on [12V] terminal → positive on [⚡] terminal → negative | 13,8 0 | — |

Table 8 Terminals description



BENTEL SECURITY s.r.l.
Via Gabbiano, 22 - Zona Ind. S. Scolastica
64013 Corropoli (TE) - ITALY
Tel.: +39 0861 839060
Fax: +39 0861 839065
e-mail: infobentelsecurity@tycoint.com
http://www.bentelsecurity.com