

DS-2SE7C124IW-AE(32x/4)(S5) 2 MP 32 × IR Network Speed Dome

AcuSense



Hikvision DS-2SE7C124IW-AE(32x/4)(S5) 2 MP 32 × IR Network Speed Dome adopts 1/2.8" progressive scan CMOS chip. With the 32 × optical zoom lens, the camera offers more details over expansive areas. This series of cameras can be widely used for wide ranges of high-definition, such as rivers, roads, railways, airports, squares, parks, scenic spots, and venues, etc. Empowered by deep learning algorithms, Hikvision AcuSense technology brings human and vehicle targets classification alarms to front- and back-end devices. The system focuses on human and vehicle targets, vastly improving alarm efficiency and effectiveness.

- 1/2.8" Progressive Scan CMOS
- Up to 2560 × 1440 @ 30 fps resolution
- Excellent low-light performance with powered-by-DarkFighter technology
- 32 × optical zoom, 16 × digital zoom
- WDR, HLC, BLC, 3D DNR, Defog, Regional Exposure, Regional Focus, Rapid Focus
- Up to 150 m IR distance
- 24 VAC & Hi-PoE
- Support H.265+/H.265 video compression
- Audio visual alarm: The white flashing light and audible warning can be triggered by certain events, and the warning content is selectable



▪ Specification

Camera Module	
Image Sensor	[panoramic channel]: 1/2.8" Progressive Scan CMOS; [PTZ channel]: 1/2.8" progressive scan CMOS
Min. Illumination	[PTZ channel]: Color: 0.005 Lux @ (F1.2, AGC ON), B/W: 0.001 Lux @ (F1.2, AGC ON); [panoramic channel]: 0.005 Lux @ (F1.6, AGC ON), 0 Lux with IR
Shutter Speed	1/1 s to 1/30000 s
Slow Shutter	yes
Focus	semi-auto, manual, auto
Day & Night	ICR
Day/Night Switch	day, night, auto, scheduled-switch
BLC	yes
WDR	120 dB WDR
HLC	yes
3D DNR	yes
Defog	yes
EIS	yes
Regional Exposure	yes
Regional Focus	yes
Image Settings	saturation, brightness, contrast, sharpness
White Balance	auto, ATW, sodium lamp, fluorescent lamp, indoor, outdoor, MWB, locked WB
Digital Zoom	16 ×
Optical Zoom	32 ×
Privacy Mask	polygon region, mosaic mask, mask color configurable, [panoramic channel] 8 masks [PTZ channel] 4 masks
SNR	> 52 dB
Lens	
Focal Length	[panoramic channel]: 4 mm; [PTZ channel]: 4.8 to 153 mm, 32 ×
Zoom Speed	approx. 4.2 s
FOV	[panoramic channel]: Horizontal field of view: 79°, Vertical field of view: 42.4°; [PTZ channel]: Horizontal field of view: 58.4° to 2.14° (wide-tele), Vertical field of view: 33.8° to 1.2° (wide-tele), Diagonal field of view: 65.6° to 2.46° (wide-tele)
Aperture	[panoramic channel]: F1.6; [PTZ channel]: F1.2
PTZ	
Movement Range (Pan)	360°
Movement Range (Tilt)	-15° to 90°(auto flip)
Pan Speed	pan speed: configurable from 0.1° to 160°/s; preset speed: 240°/s
Tilt Speed	tilt speed: configurable from 0.1° to 120°/s, preset speed 200°/s
Proportional Zoom	yes
Presets	300
Patrol Scan	8 patrols, up to 32 presets for each patrol
Pattern Scan	4 pattern scans
Power-off Memory	yes
Park Action	preset, pattern scan, patrol scan, auto scan, tilt scan, random scan, frame scan, panorama scan
3D Positioning	yes
PTZ Status Display	yes
Preset Freezing	yes
Scheduled Task	preset, pattern scan, patrol scan, auto scan, tilt scan, random scan, frame scan, panorama scan, dome reboot, dome adjust, aux output
Video	
Max. Resolution	2560 × 1440
Stream Type	main stream, sub-stream, third stream

Main Stream	[panoramic channel]: 50 Hz: 25 fps (2560 × 1440, 1920 × 1080, 1280 × 960, 1280 × 720); 60 Hz: 30fps (2560 × 1440, 1920 × 1080, 1280 × 960, 1280 × 720) [PTZ channel]: 50 Hz: 25 fps (1920 × 1080, 1280 × 960, 1280 × 720); 60 Hz: 30 fps (1920 × 1080, 1280 × 960, 1280 × 720)
Sub-Stream	[panoramic channel]: 50 Hz: 25 fps (704 × 576, 640 × 480, 352 × 288); 60 Hz: 30 fps (704 × 480, 640 × 480, 352 × 240) [PTZ channel]: 50 Hz: 25 fps (704 × 576, 640 × 480, 352 × 288); 60 Hz: 30 fps (704 × 480, 640 × 480, 352 × 240)
Third Stream	[panoramic channel]: 50 Hz: 25 fps (1920 × 1080, 1280 × 960, 1280 × 720, 704 × 576, 640 × 480, 352 × 288); 60 Hz: 30 fps (1920 × 1080, 1280 × 960, 1280 × 720, 704 × 480, 640 × 480, 352 × 240) [PTZ channel]: 50 Hz: 25 fps (1920 × 1080, 1280 × 960, 1280 × 720, 704 × 576, 640 × 480, 352 × 288); 60 Hz: 30 fps (1920 × 1080, 1280 × 960, 1280 × 720, 704 × 480, 640 × 480, 352 × 240)
Video Compression	H.265, H.264, MJPEG
Video Bit Rate	32 kbps to 16384 kbps
H.264 Type	baseline profile, main profile, high profile
H.265 Type	main profile
H.264+	yes
H.265+	yes
SVC	yes
ROI	main stream, sub-stream and third stream respectively support eight fixed areas
Audio	
Audio Compression	G.711alaw, G.711ulaw, G.722.1, G.726, MP2L2, PCM
Audio Bit rate	MP2L2: 32 kbps, 40 kbps, 48 kbps, 56 kbps, 64 kbps, 80 kbps, 96 kbps, 112 kbps, 128 kbps, 144 kbps, 160 kbps, 192 kbps
Audio Sampling Rate	MP2L2: 16 kHz, 32 kHz, 48 kHz, PCM: 8 kHz, 16 kHz, 32 kHz, 48 kHz
Environment Noise Filtering	yes
Smart Features	
Face Capture	Support detecting up to 5 faces at the same time. Support detecting, tracking, capturing, grading, selecting of face in motion, and output the best face picture of the face
Basic Event	motion detection, alarm input, alarm output, exception
Smart Event	intrusion detection, line crossing detection, region entrance detection, region exiting detection, audio exception detection
Smart Tracking	manual tracking, panorama tracking, event tracking, auto-tracking, tracking takeover
Smart Record	ANR, Dual-VCA
Alarm Linkage	preset, patrol scan, pattern scan, memory card video recording, alarm output, sending email, notify surveillance center, upload to FTP, smart tracking
Perimeter Protection	Line crossing, intrusion, region entrance, region exiting Support alarm triggering by specified target types (human and vehicle)
Network	
Network Storage	NAS (NFS, SMB/ CIFS), ANR
Protocols	IPv4/IPv6, HTTP, HTTPS, 802.1x, Qos, FTP, SMTP, UPnP, SNMP, DNS, DDNS, NTP, RTSP, RTCP, RTP, TCP/IP, UDP, IGMP, ICMP, DHCP, PPPoE, Bonjour
API	ISAPI, Hikvision SDK, ONVIF (Profile S, Profile G, Profile T), ISUP
Simultaneous Live View	20
User/Host	32
Smooth Streaming	yes
Security Measures	Authenticated username and password, MAC address binding, HTTPS encryption, 802.1X authenticated access, IP address filter
Client	iVMS-4200, Hik-Connect, HikCentral
Web Browser	IE 10+, Chrome 57+, Firefox 52+, Safari 12+
Interface	
Communication Interface	RJ45, self-adaptive 10M/100M Ethernet port
On-board Storage	support microSD/microSDHC/microSDXC cards, up to 256 GB
Alarm Input	2 alarm inputs
Alarm Output	1 alarm output

Audio Input	1 audio input
Audio Output	1 audio output, line level, impedance: 600 Ω
Supplement Light	
IR Distance	150 m
General	
Power	24 VAC, Hi-PoE
Power Consumption and Current	Max. 60 W, including max. 3.7 W for heater and max. 16 W for supplement light
Operating Conditions	-30°C to 65°C (-22°F to 149°F), humidity: ≤ 90%
Reset	yes
Demist	Demist by heating the glass
Material	ADC 12, PC, PC+10%GF
Dimensions	∅ 220.0 mm × 373.3 mm (∅ 8.7" × 14.7")
Weight	Approx. 6 kg (13.23 lb.)
Approval	
Protection	IP66 Standard, IK10 (excluding glass window), 6000 V Lightning Protection, Surge Protection and Voltage Transient Protection

▪ DORI

The DORI (detect, observe, recognize, identify) distance gives the general idea of the camera ability to distinguish persons or objects within its field of view. It is calculated based on the camera sensor specification and the criteria given by EN 62676-4: 2015.

DORI	Detect	Observe	Recognize	Identify
Definition	25 px/m	63 px/m	125 px/m	250 px/m
Distance (Tele)	3060.0 m (10039.4 ft)	1214.3 m (3983.9 ft)	612.0 m (2007.9 ft)	306.0 m (1004.0ft)

▪ Dimension

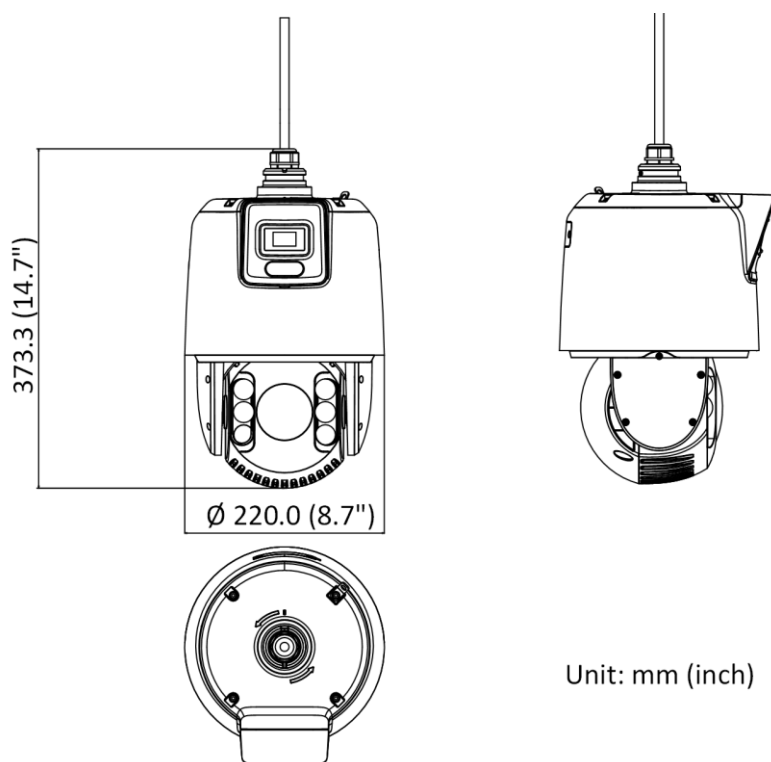

▪ Accessory

▪ Optional



DS-1661ZJ
Pendant Mount



DS-1602ZJ
Wall Mount



DS-1602ZJ-corner
Corner Mount



DS-1602ZJ-pole
Pole Mount



DS-1681ZJ-2
Installation Adapter



DS-2681ZJ
Cardan Joint

▪ Available Model

DS-2SE7C124IW-AE(32x/4)(S5)

Distributed by



HIKVISION®

Headquarters

No.555 Qianmo Road, Binjiang District,
Hangzhou 310051, China
T +86-571-8807-5998
overseasbusiness@hikvision.com

Hikvision USA
T +1-909-895-0400
sales.usa@hikvision.com

Hikvision Australia
T +61-2-8599-4233
salesau@hikvision.com

Hikvision India
T +91-22-28469900
sales@pramahikvision.com

Hikvision Canada
T +1-866-200-6690
sales.canada@hikvision.com

Hikvision Thailand
T +662-275-9949
sales.thailand@hikvision.com

Hikvision Europe
T +31-23-5542770
sales.eu@hikvision.com

Hikvision Italy
T +39-0438-6902
info.it@hikvision.com

Hikvision Brazil
T +55 11 3318-0050
Latam.support@hikvision.com

Hikvision Turkey
T +90 (216)521 7070- 7074
sales.tr@hikvision.com

Hikvision Malaysia
T +601-7652-2413
sales.my@hikvision.com

Hikvision UK & Ireland
T +01628-902140
sales.uk@hikvision.com

Hikvision South Africa
Tel: +27 (10) 0351172
sale.africa@hikvision.com

Hikvision France
T +33(0)1-85-330-450
info.fr@hikvision.com

Hikvision Kazakhstan
T +7-727-9730667
nikia.panfilov@hikvision.ru

Hikvision Vietnam
T +84-974270888
sales.vt@hikvision.com

Hikvision UAE
T +971-4-4432090
salesme@hikvision.com

Hikvision Singapore
T +65-6684-4718
sg@hikvision.com

Hikvision Spain
T +34-91-737-16-55
info.es@hikvision.com

Hikvision Tashkent
T +99-87-1238-9438
uzb@hikvision.ru

Hikvision Hong Kong
T +852-2151-1761
info.hk@hikvision.com

Hikvision Russia
T +7-495-669-67-99
saleru@hikvision.com

Hikvision Korea
T +82-(0)31-731-8817
sales.korea@hikvision.com

Hikvision Poland
T +48-22-460-01-50
info.pl@hikvision.com

Hikvision Indonesia
T +62-21-2933759
Sales.Indonesia@hikvision.com

Hikvision Colombia
sales.colombia@hikvision.com